

CFP 2/4/8 ZONE
FIRE ALARM
REPEATER PANEL

**installation &
maintenance
manual**

approved document no. DFU7003001 rev 2



CONTENTS

Important Notes	3
Basic Overview and Key Features	4
First Fix	5
Cable types and limitations	5
Mains wiring	5
Mounting the enclosure	8
Second Fix	8
Installing the Power Supply PCB	8
Connecting the Mains	8
Connecting the Stand-by batteries	8
Installing the Network Driver Card	10
Setting the Network Driver Card's address and segment number	11
Connecting the Network wiring	12
Installing the Main Control PCB	12
Fault Diagnosis	13
Technical Specifications	14

© 2002. Errors & Omissions Excepted. The Manufacturer of this product operates a policy of continuous improvement and reserves the right to alter product specifications at its discretion and without prior notice. All of the instructions covered in this manual have been carefully checked prior to publication. However, no responsibility can be accepted by the Manufacturer for any inaccuracies or for any misinterpretation of an instruction or guidance note.

IMPORTANT NOTES



This equipment must only be installed and maintained by a suitably skilled and technically competent person.

THIS EQUIPMENT IS A PIECE OF CLASS 1 EQUIPMENT AND MUST BE EARTHED

About this manual

This Installation & Maintenance Manual explains how to install, commission and maintain the Repeater Panel. It must be read in conjunction with the separate User Manual / Log Book and the main Installation / Maintenance Manual, both of which are supplied with the Master panel.

This Manual must not be left accessible to the User.

System design

Fire Alarm system design is beyond the scope of this document. A basic understanding of general Fire Alarm System components and their use is assumed.

We strongly recommend that a suitably qualified and competent person is consulted in connection with the design of the Fire Alarm System and that the System is commissioned and serviced in accordance with the laid down specification and National standards. The Fire Officer concerned with the property should be contacted at an early stage in case he has any special requirements.

We recommend you read BS 5839: Pt 1: 1988 "Fire Detection and Alarm Systems for Buildings (Code of Practice for System Design, Installation and Servicing)" available at your local reference library or from the BSI.

Equipment guarantee

This equipment is not guaranteed unless the complete system is installed and commissioned in accordance with the laid down National standards by an approved and competent person or organisation.

Caution : Important Notice



WHEN CONNECTED, THE POWER SUPPLY PCB INSIDE THE FIRE ALARM PANEL STORES VOLTAGES AT UP TO 400Vd.c. AND MAY BE LETHAL IF TOUCHED. DO NOT TOUCH THE PCB WHILST THE RED 'HAZARDOUS VOLTAGE PRESENT' INDICATOR IS LIT.

Anti-static handling guidelines



Please ensure that the following electro-static handling precautions are taken immediately prior to handling the Panel's PCBs or any other static-sensitive components.

Before handling any static-sensitive items, operators should rid themselves of any personal electro-static charge by momentarily touching any sound connection to safety earth, e.g. a radiator.

Always handle PCBs by their sides and avoid touching the legs of any components.

PCBs should be stored in a clean, dry place which is free from vibration, dust and excessive heat.

Retaining the PCBs in a suitable cardboard box will also guard them against mechanical damage.



This product has been manufactured in conformance with the requirements of all applicable EU Council Directives.

BASIC OVERVIEW & KEY FEATURES

A maximum of eight Repeaters can be used per system, each with its own mains power supply and requiring its own battery-back-up supply.

Each Repeater repeats the indicators of the Master panel and allows the User access to all Access Level 1 and Access Level 2 functions from remote parts of a site.

Communication with the Master panel is achieved using network driver cards (one provided per Repeater), communicating over screened two-wire fire resistant cable of up to 1 km in length.

To allow communication to take place, an additional network driver card must be fitted at the Master panel.

The Repeater panel's enclosure is flush or surface mountable

FIRST FIX

The Network wiring should be installed to meet BS 5839: Pt1: 1988 and BS 7671 (Wiring Regulations). Other National standards of installation should be used where pertinent.

Cable types and limitations

The Repeater network should be wired in two core screened fire resistant cable, each of the cores being of at least 1mm c.s.a. (E.g. Firetuff, Firecell, MICC or similar). The wiring should be laid out in a daisy chain configuration, i.e. not in a star, and with no spurs. End of line terminations are not required, and no special consideration is required for the positioning of the Main panel or the addressing order of the Repeaters. The total cable length should not exceed 1km. Please refer to the typical Repeater Network diagram shown below:

Fig 1 : Typical Repeater Network Wiring

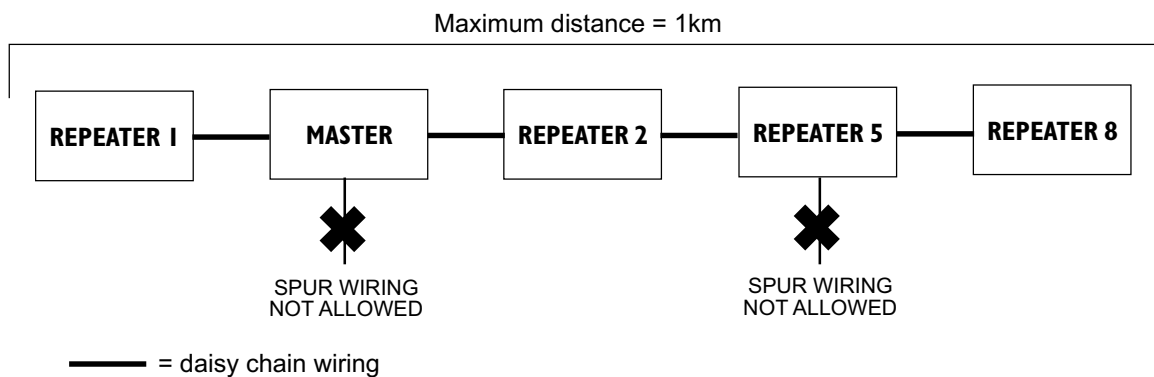

To avoid data corruption and earth loops, the Repeater network wiring screens should be connected to earth at the Master panel only.

Power Supply

Each repeater includes its own Power Supply that must be supplied locally from the Mains, and also requires a backup battery supply. The power is not drawn from the Master panel as this would demand much larger batteries in the Master panel and the connection of extra power carrying conductors.

Mains wiring

The requirement for the Mains supply to the Repeater is fixed wiring, using three core cable (no less than 0.75mm² and no more than 2.5mm²) or a suitable three conductor system, fed from an isolating switch fuse spur, fused at 3A. This should be secure from unauthorised operation and be marked 'FIRE ALARM: DO NOT SWITCH OFF'. The Mains supply must be exclusive to the Repeater Panel.

For information on how to connect Mains to the Panel's Power Supply PCB, see pages 8 and 9.

Mounting the Enclosure

Panel location

The panel MUST be sited internally in an area which is NOT subject to conditions likely to affect its performance, e.g. damp, salt-air, water ingress, extremes of temperature, physical abuse, etc. It should be sited at a height where it is easily accessible and in a prominent position within the building. Ideally, the indicators on the front of the enclosure should be at eye level.

Typical locations for repeaters are at alternative entrances to a building (the Master should always be fitted at the entrance most likely to be used by the emergency services), or on each floor of a multi-storey building.

Enclosure details

The repeater is supplied with a plastic detachable lid, a plastic back box and a three separate PCBs. The relative location of the PCBs are indicated in Figure 1 below:

The Panel can be surface or semi-flush mounted. To expose the base mounting holes, the base PCBs must first be removed.



Removing the lid and base PCBs

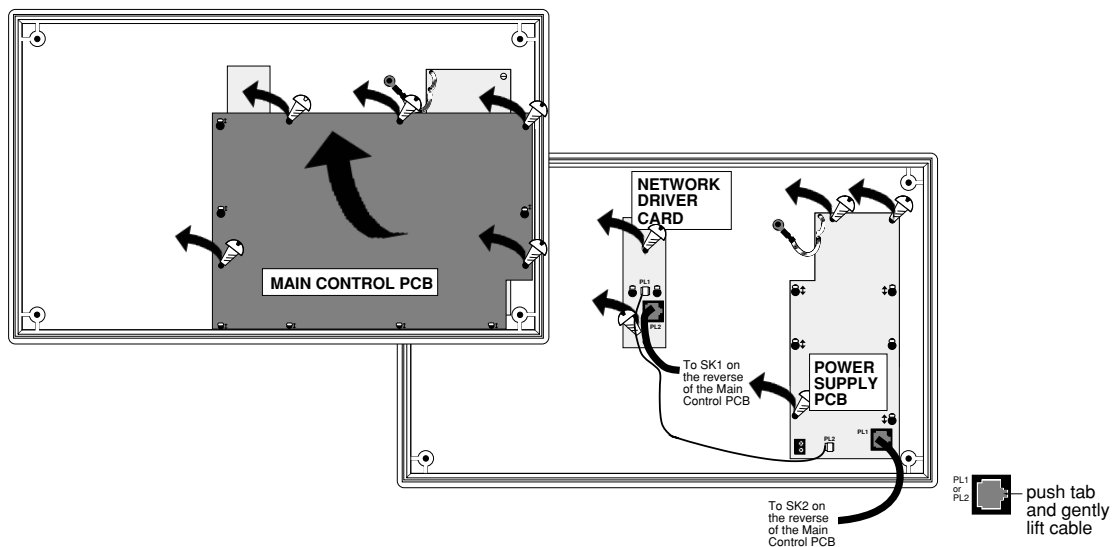

PCBs are static-sensitive devices. We strongly advise that relevant anti-static handling precautions are observed when handling them (see page 3 for recommended guidelines).

Figure 2 : Location of the Repeater Panel's base PCBs and removal details



- 1 Take the repeater panel out of its box and undo the four lid screws using the torx key provided. Remove the lid to expose the Main Control PCB (the Power supply PCB and Network Driver Card are located underneath).
- 2 Carefully remove the five retaining screws  on the Main Control PCB and slide the PCB up and over the mounting pillars, taking care not to damage any of the components.
- 3 Disconnect the telecoms-style connecting cables at PL1 on the Power Supply PCB and PL2 on the Network Driver Card, making sure that the cables remain connected to the reverse of the Main Control PCB to prevent them being misplaced. Care should be taken when detaching this connector to depress the locking tab to prevent damage.
- 4 Disconnect the 2-way polarised loom from PL2 on the Power Supply PCB and pull the Power Supply's earth strap off the spade connector at the main chassis earth point.
- 5 Carefully remove the three retaining screws  on the Power Supply PCB and slide the PCB up and over the mounting pillars, again taking care not to damage any of the components.
- 6 Carefully remove the two retaining screws  on the Network Driver Card and slide the card up and over the mounting pillars, again taking care not to damage any of the components.

We recommend the lid and PCBs are now removed from site to prevent accidental damage.
Storing the PCBs in a suitable cardboard box will also guard them against mechanical damage.

Removing the knock-outs

Decide carefully how the network wiring will be brought into the panel with reference to figure 3 below and remove the required knock-outs for cable entry.

The knock-outs should be removed with a sharp tap in the rim of the knock-out using a flat broad-bladed screwdriver. Use of excessive force could damage the enclosure around the knock-out.

Always ensure if a knock-out is removed, the hole is filled with a good quality cable gland. Any unused knock-outs must be securely blanked off.

It is essential that the 230Va.c. Mains cable is fed into the enclosure via one of the inlets at the top right hand corner of the enclosure. (For further CRITICAL information on Mains connection please refer to "Connecting the Mains" on Pages 8 and 9).

Fixing the base to the wall

Figure 3 : Internal view of back box with PCBs removed / side view for flush mounting

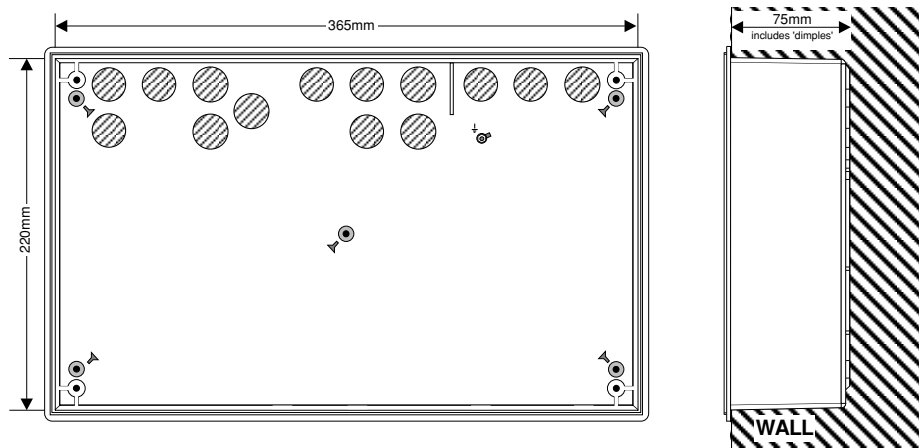

Using the five mounting holes provided, fix the base securely onto/into the wall.

The mounting holes are suitable for use with No.8 roundhead or countersunk woodscrews.

Assess the condition and construction of the wall and use a suitable screw fixing.

Any dust or swarf created during the fixing process must be kept out of the repeater panel and great care must be taken not to damage any wiring or components.

SECOND FIX

Connecting the panel

Connecting the repeater panel's internal connections and PCBs is best undertaken immediately prior to Commissioning.

Before you begin, we recommend cable integrity is verified throughout the installation.

Important: DO NOT use an insulation tester ('Megger') with any network drivers connected.

Faults occurring in the wiring which are not picked up at this stage will almost certainly result in spurious and intermittent faults when the equipment is energised.

Installing the Power Supply PCB

The Power Supply PCB combines the functions of a Mains to d.c. switched mode power supply unit, battery charging unit and battery monitoring unit.



WHEN CONNECTED, THE POWER SUPPLY PCB STORES VOLTAGES AT UP TO 400Vd.c. AND MAY BE LETHAL IF TOUCHED. DO NOT TOUCH THE PCB WHILST THE RED 'HAZARDOUS VOLTAGES PRESENT' INDICATOR IS LIT.

Under no circumstances should the repeater panel be operated without the Power Supply PCB correctly mounted in the panel's enclosure and the three retaining screws securely tightened.

The PCB should be positioned in the panel as shown in Figure 4 on Page 9.

Connecting the Mains

The general requirement for the Mains supply to this equipment is described on Page 5.

DO NOT attempt to connect Mains to the panel until you are fully conversant with the layout and features of the Power Supply PCB, as described above and in Figure 4 on Page 9.

The incoming Mains cable should be brought into the panel at the top right hand side of the enclosure and terminated at the connector block (CONN1) on the Power Supply PCB. Make sure the Mains earth wire is connected directly to this connector block and NOT to the secondary base earth post which is provided for making off detector and sounder circuit screens.



The Power Supply PCB's earth strap MUST be connected to the spade on the chassis earth post before operation. The spade is compressed against a shoulder on the post via the lowest nut. The earth post may appear loose, this intended by design.

Connecting the stand-by batteries

Two new, good quality and fully charged 12V Valve Regulated Lead Acid batteries are required as the emergency stand-by power supply for the repeater panel. **Caution:** No other type of batteries should be used due to risk of explosion.

The batteries should be connected in series and located in the repeater's enclosure as shown in Figure 5. The battery leads, link wire and nylon tie wraps are provided in the panel's accessory pack. Run the battery leads through the slits in the panel's lower plastic ribs and secure the batteries into position using the nylon tie-wraps as shown.

The panel's sophisticated battery monitoring unit protects the batteries against deep discharge by activating a cut off circuit when the stand-by supply voltage reaches 21V approx. If batteries are not fitted, are discharged or in poor condition, a PSU Fault will show at the repeater panel.

The capacity of the batteries used in the repeater will depend upon the required stand-by time. For 24 hour stand-by use 1.2A Hr batteries. For 72 hour stand-by use 2.1 A Hr batteries. These capacities take into account an ageing factor over a battery life of 5 years. Battery capacity for Master panels depends on other factors and therefore larger sized batteries may be required, see main panel installation instructions for details.

Always dispose of used batteries according to the battery manufacturer's instructions.

Figure 4 : Power Supply PCB layout and mains connection details

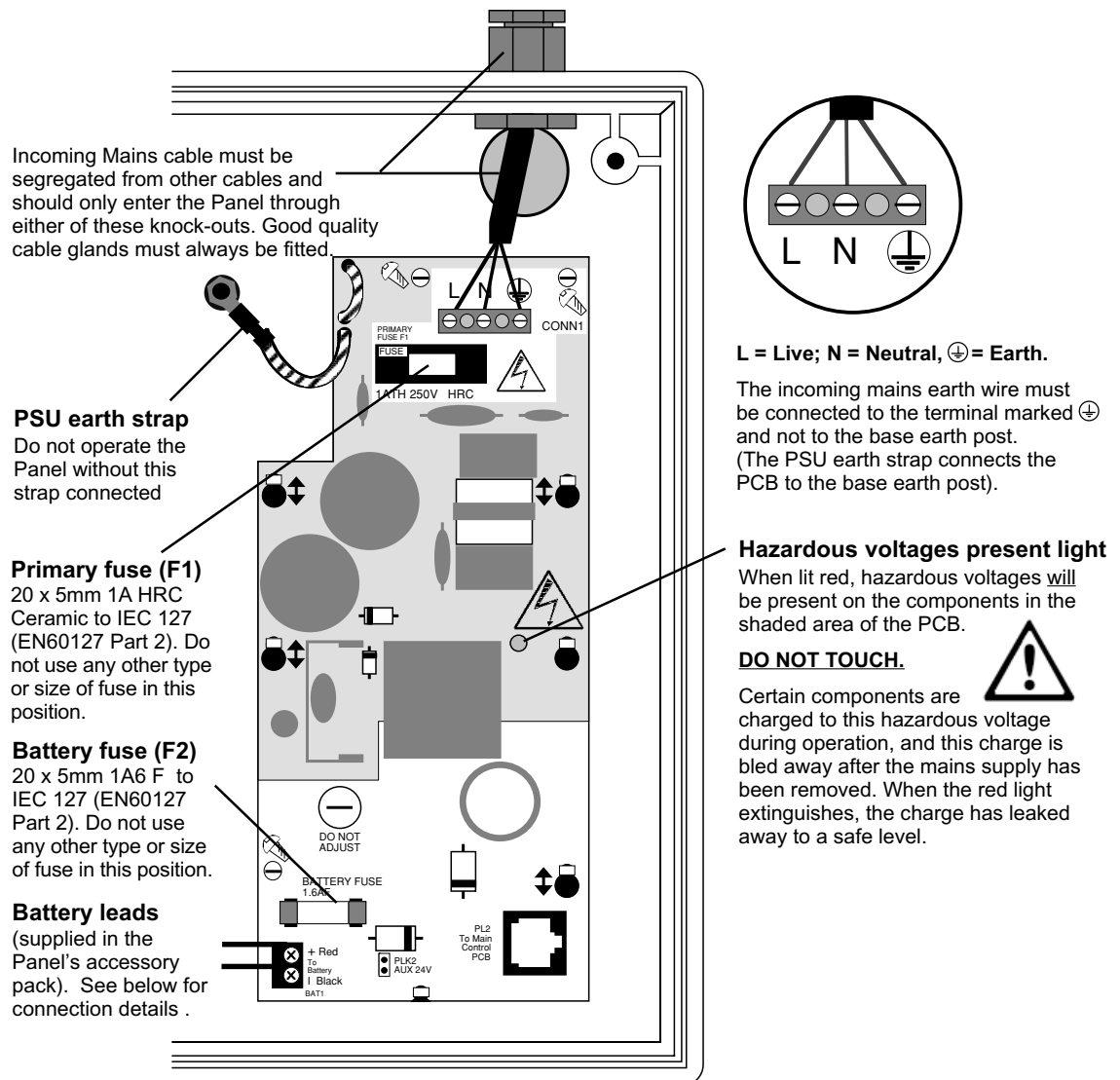
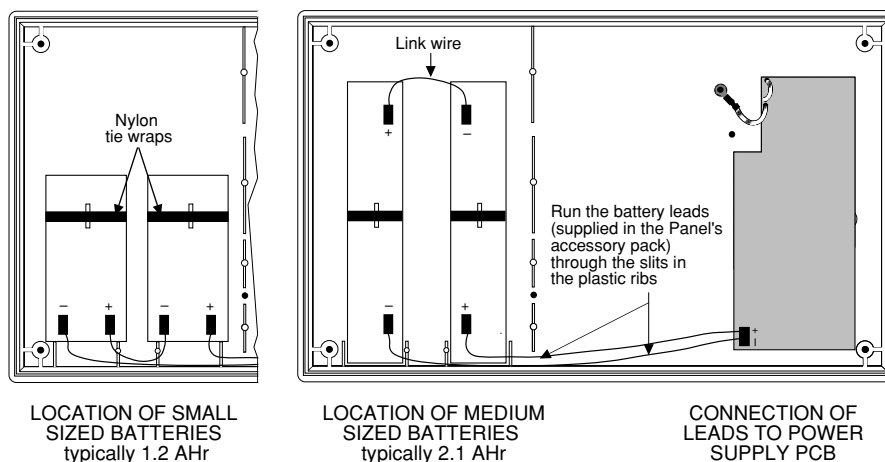

Figure 5: Battery location and connection details for repeaters



Note: larger batteries (up to 3.3 Ahr in size) will fit in the enclosure. However, these would normally only be used in master panels -refer to the main panel instructions for further details.

Installing the Network Driver Card

The repeater's Network Driver Card must be securely positioned inside the repeater panel as shown in Figure 6 (below) using the two retaining screws provided.

Figure 6 : Fitting the Network Driver Card

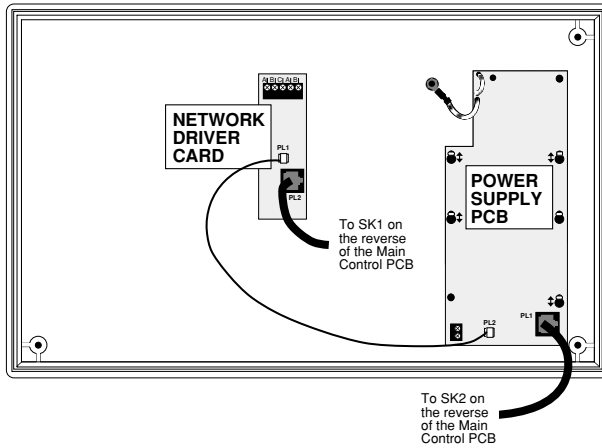

Important:
Before installing the Network Driver Card, isolate the Mains supply and disconnect the panel's battery back-up supply.

(Mains can be removed by carefully pulling the 5mm connector block, CONN1, from the Power Supply PCB).

Connect the two-way polarised power supply loom between PL1 on the Network Driver Card and PL2 on the Power Supply PCB as shown.



An additional Network Driver Card must also be fitted at the Master panel. This should be installed in exactly the same way as above UNLESS the Master panel has a Relay Output Board fitted, in which case Figure 7 (below) should be referenced instead.

Figure 7: Fitting the Network Driver Card to a Master Panel with a Relay Output Board

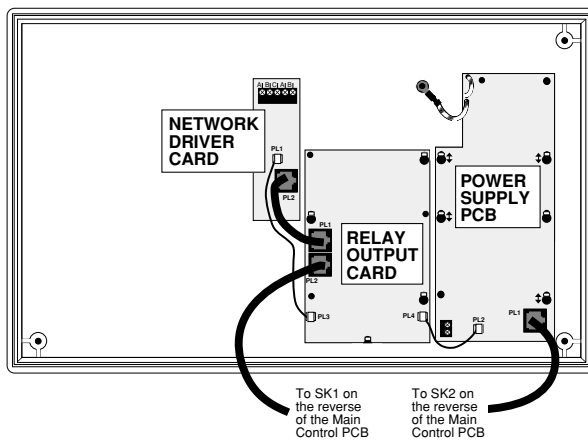

Important:
Before installing the Network Driver Card, isolate the Mains supply and disconnect the Panel's battery back-up supply.

(Mains can be removed by carefully pulling the 5mm connector block, CONN1, from the Power Supply PCB).

When fitting a Network Driver Card to a Master Panel which has a Relay Output Board fitted:-

Connect the Network Driver Card's two-way power supply loom between PL1 on the Network Driver Card and PL2 on the Relay Output Board.

Connect the Network Driver Card's telecoms-style data connection cable between PL2 on the Network Driver Card and PL1 on the Relay Output Board.

If in doubt, please refer to the instructions supplied with the Relay Output Board itself.

IMPORTANT: Before proceeding to fit the repeater and Master panel's Main Control PCBs, you must first assign their Network Driver Cards with an address and segment number, as described on page 11.

Setting the Network Driver Card's address and segment number

The Master panel monitors any repeaters connected to it by periodically checking their address numbers. Each repeater must therefore have its own unique address number assigned to it, as should the Master panel itself. Also, for future expansion, every Network device must be identified by means of its Segment. All repeaters (and the Master panel) must belong to the same Segment and we suggest that Segment number 1 is used throughout the repeater network.

Up to eight repeaters may be connected to one Master panel. Their Address and segment numbers, and those of the Master, are set via the 8 Way switch on the Network Driver Card, as detailed in Figure 8 below:-

Figure 8 : Network Driver Card Address and Segment numbers

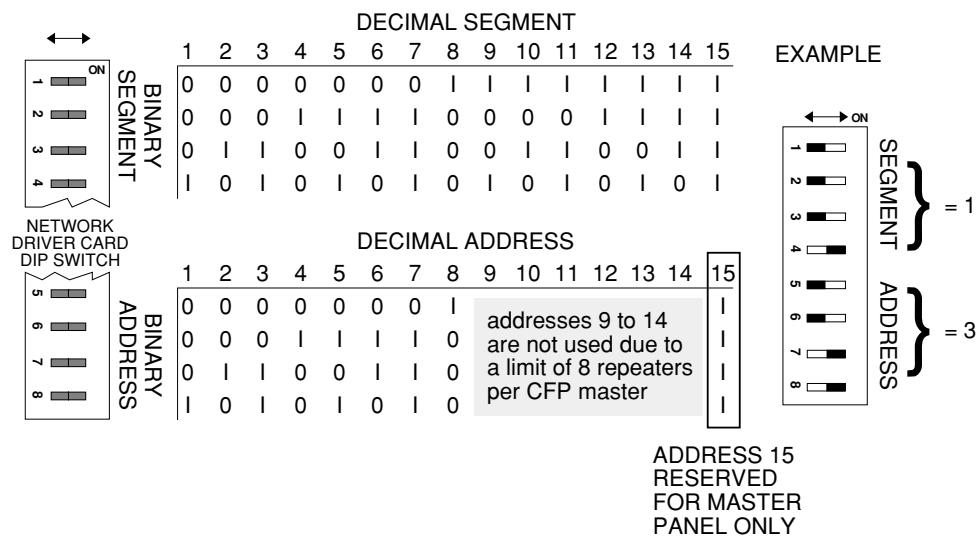

Please note that address 0 must not be used and that the Master panel's address must always be set at 15.

The addresses of the repeaters do not need to run sequentially, i.e. it is permissible to have just repeater addresses 2 and 5 on the system. However, no two repeaters should have the same address. Repeaters can also be addressed in any order on the Network wiring.

Network Driver Cards only read their 8 Way switches when they are powered up, so changing their addresses whilst they are powered up has no effect.

The Master panel looks for the presence of repeater panels all the time. Once a repeater is seen, but then disappears, the Master panel shows this as a fault. See fault diagnosis section on page 13 for further details.

If a repeater needs to be removed from the system, simply remove the power from the system, disconnect the repeater, then power the system back up. The Master panel will now only see the repeaters that are left on the system.

Connecting the Network wiring

Connect the network wiring to the relevant Network Driver Cards as illustrated in Figure 9 below. (It should be noted that the network driver cards' terminal blocks can be removed from their PCBs for ease of installation).

At the Master panel only, all network earth screens should be adequately insulated and connected to the base earth post as shown. The base earth must then be connected to terminal C on the master panel's Network Driver Card.

At Repeater panels, all incoming and outgoing network earth screens should be connected to terminal C only. DO NOT connect the screens to the repeater's base earth post and DO NOT connect the repeater's base earth post to terminal C.

Figure 9: Typical Network Wiring

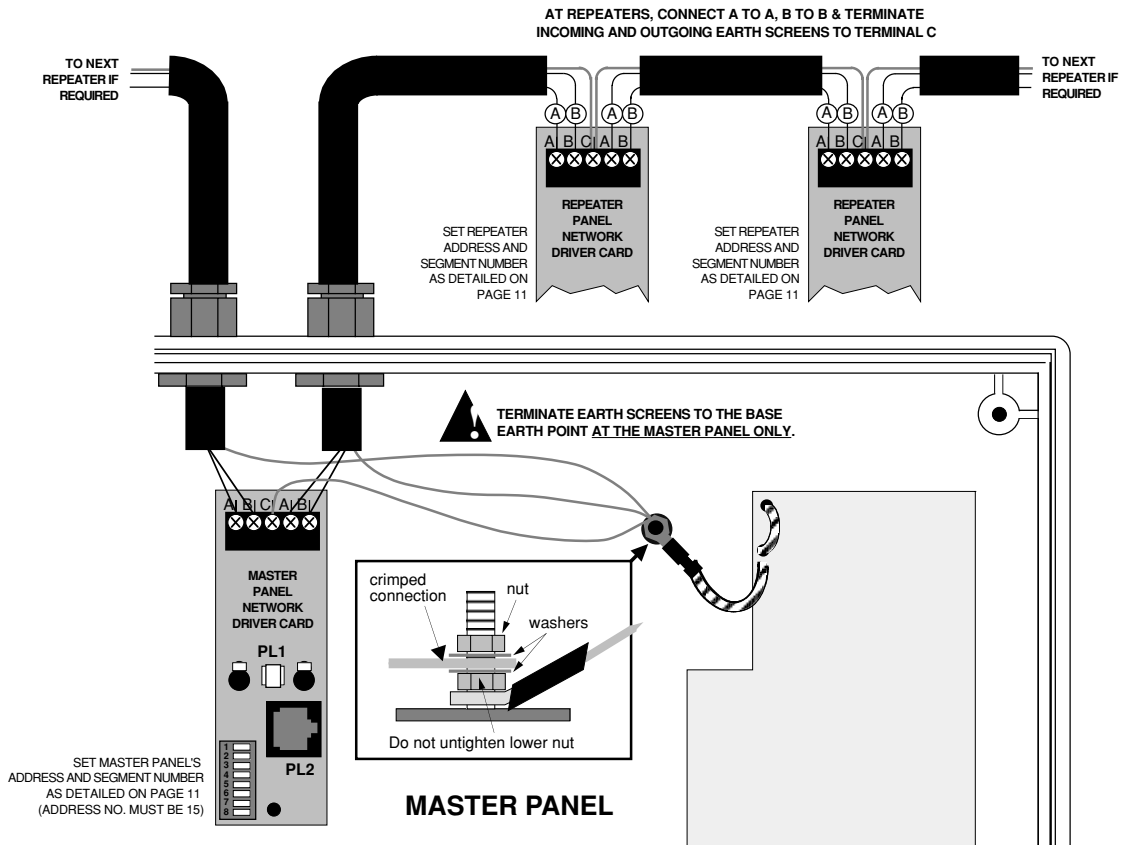

Installing the Main Control PCB

When all of the Network wiring is in place, the repeater's Main Control PCB can be securely positioned inside the panel using the five retaining screws. (Isolate the Mains supply and disconnect the battery back-up supply before you do this).

As the PCB is presented to the panel, remember to attach the two telecoms-style connecting cables to the Power Supply PCB and Network Driver Card PCB as described below:

- SKT1 on the reverse of the Main Control PCB to PL1 on the Power Supply PCB
- SKT2 on the reverse of the Main Control PCB to PL2 on the Network Driver Card

On Master panels only, if a Relay Output Card is fitted, SKT2 on the Main Control PCB should be connected to PL2 on the Relay Output Card.



CAUTION: Do not connect the two telecom style cables incorrectly as this will cause irreparable damage to the Main Control PCB when the panel is powered up. If in doubt, refer to figures 6 and 7 on page 10.

When all of the PCBs are correctly in place, reapply power and test the system for correct operation.

FAULT DIAGNOSIS

Overview

If a repeater loses power, but is still connected to the network, it will not stop the rest of the repeater network operating. However, short and open circuits on the network wiring will cause complete or partial loss of communication between the Master panel and the Repeaters.

The Master panel's Repeater Fault light flashes yellow when it cannot communicate with one or more repeaters. To ascertain which of the repeater panels are faulty:-

1. Remove the Master panel's lid and press the Access Level Three Functions button on the Main Control PCB to gain access to the panel's Engineer functions (see below).

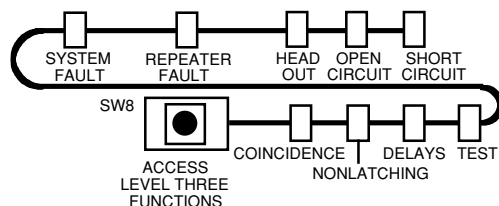

2. Continue pressing the Access Level Three Functions button until the Repeater Fault light pulses.

Any existing zone fault indicators are suppressed and the zone indicator(s) corresponding to the repeaters in Fault are illuminated. For example, if repeater 2 and 7 are faulty, the Fault indicators for zones 2 and 7 will be lit.

To escape Access Level Three press the "Escape Access" button at any time.

Repeater Power Supply Faults

Failure of a repeater panel's PSU is shown locally and is indicated by the Repeater's Power Supply Fault indicator flashing yellow.

A Power Supply Fault is indicative of one or more of the following faults. Pages 8 & 9 of this manual **must** be referenced when carrying out any of the suggested action described below.

■ The Mains supply is too low or has failed completely.

Symptoms: the panel runs on batteries, but not on Mains. The red hazardous voltages present light on the Power Supply PCB is lit.

Suggested action:

- (a) Isolate the Mains supply and remove the Mains connector block (CONN1) from the Power Supply PCB.
- (b) Position the connector block so that the live and neutral connections can be probed. Taking all due precaution, reapply the Mains and measure the voltage.
- (c) Isolate the Mains supply again.

If the reading was incorrect (see Technical Specifications, page 14) repair the Mains supply.

If the reading was correct, check again to see if the red hazardous voltages present light on the Power Supply PCB is lit. If it is and the panel still doesn't run on Mains, the Power Supply PCB is faulty and should be replaced.

■ The Primary Mains fuse (F1) is ruptured.

Symptoms: the panel runs on batteries, but not on Mains. The red hazardous voltages present light on the Power Supply PCB is off.

Suggested action:

- (a) Isolate the Mains supply, remove the Main Control PCB and check the PSU's Primary Mains fuse (F1) for continuity.
- (b) If the Fuse is ruptured it will be due to excessive Mains surge or a PSU fault.

Check the components on the PSU for damage. If none is found replace the fuse with the correct type and reconnect the Mains supply. If the red hazardous voltages present light does not come on with 220V Mains applied and a good fuse, then the PSU is faulty and should be replaced.

(continued overleaf)

■ **The Battery Fuse (F2) is ruptured.**

Symptoms: the panel runs on Mains, but not on batteries.

Suggested action:

- (a) Isolate the Mains supply and disconnect the batteries.
- (b) Remove the Main Control PCB and check the Battery Fuse (F2) on the Power Supply PCB for continuity.
- (c) If the fuse is ruptured check the Power Supply PCB and Main Control PCB for signs of damage. If none is found, replace the Fuse with the correct type, ensuring that the fuse clip is not damaged when re-inserting the fuse.
- (d) Refit the Main Control PCB and reconnect the batteries.

If the green 'Supply Present' light is lit, reconnect the Mains supply and check that the power supply fault has cleared. If the 'Supply Present' light is not lit, either the Power Supply PCB or the Main Control PCB is faulty and should be replaced.

- (e) If the Battery Fuse (F2) is intact, proceed to check the battery voltage (see below).

■ **The Battery voltage is too low.**

Symptoms : the Panel runs on Mains, but may or may not run on batteries.

If the Mains supply has failed and the battery supply has been discharged to the point where the voltage is too low (i.e less than 21V), the panel will automatically turn off to avoid damaging the batteries by allowing them to deep discharge. The panel will not restart unless fresh, fully charged batteries are connected, or the Mains supply is restored.

CFP REPEATER PANEL TECHNICAL SPECIFICATIONS	
Mains supply voltage	230 V ±10% 50/60Hz
Internal power supply	27Vd.c.Nominal
Supply and battery charger monitored for failure	YES (battery charger is also temperature compensated)
Batteries monitored for disconnection & failure	YES
Batteries protected against deep discharge	YES (Deep discharge cut off approx. 21 Volts)
Battery size and type (for 24 hours stand-by)	2 x 12V 1.2A Hr VRLA (Valve Regulated Lead Acid) connected in series
Battery size and type (for 72 hours stand-by)	2 x 12V 2.1A Hr VRLA (Valve Regulated Lead Acid) connected in series
Mains Fuse	240V 1A HRC Ceramic 20mm compliant to IEC (EN60127 PT2)
Battery Fuse	1.6A F 20mm compliant to IEC (EN60127 PT2)
Maximum network cable length	1 km
Physical size / Dimensions	Size = 380 x 235 x 96mm approx;
Weight (without batteries)	1.75kg
Operating conditions	All components are selected to operate within their specification when conditions outside the enclosure comply with class 3k5 of IEC 721-3-3:1978. -5 to +40°C