

# Next

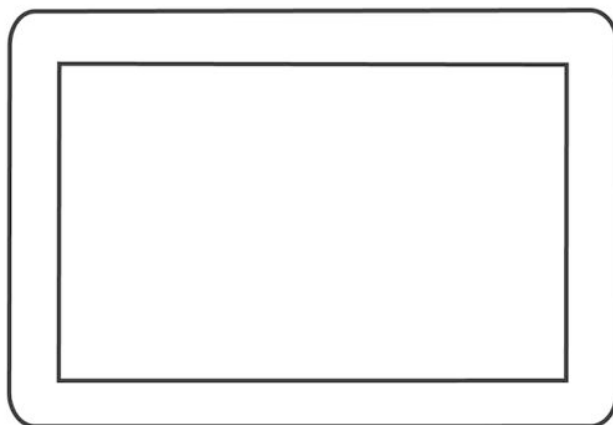

Z7000-Z7100

**VIDEO DOOR PHONE INSTALLATION ART. Z7000 - Z7100**

**Installing from semi-surface mounted:**

Install the monitor away from sources light and heat.

Install the flush-mounted back box type:

Vimar V71303 - V71318

ELVOX 6149

Bticino 503E (horizontal - vertical) – 506E

on the wall at a height of approximately 1.45 m from the floor to the lower edge, as indicated in the figure.

Carry out the wiring according to the wiring diagrams.

Staying the video in the following way: put the monitor on the attachment plate holding it slightly raised at this point by holding down the front make a slight downward pressure

Remove the protective film from the display.

Should it be necessary to remove the video you need to lift (from bottom to top) the video frame by pressing the hook.

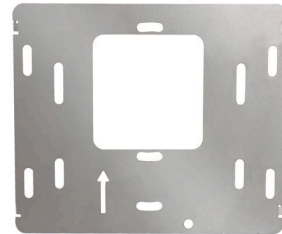

**Description connection terminal block:**

2 - Line video with RJ45 connector

PW+ - Input for additional 12V power supply (if required)

PW- - Mass supplementary feeding

FP-Connection for door call button with reference to M

AL - General alarm apartment with reference to M

P - Panic button user with respect to M

M - Mass

CH1 - Relay additional chime

CH2 – Relay additional chime

USB

**Technical characteristics:**

- Semi-surface mounted of ABS, glass parts are made from ultra-strong, scratch-proof.
- Ready for installation by Semi-surface mounted with metal coupling
- LCD 7 "capacitive touch screen
- Video Signal WVGA 800X480 Cr 500
- Camera 2Mpx with Art Z7100
- PoE alimantation
- Standby power consumption 7 mA, in conversation: 150mA
- Operating Temperature: 0 ° to 40 ° C
- Electronic chime
- Input for door call.
- Size: 189x119x21 mm

**Maintenance:**

Clean the monitor using a soft cloth, which can be dry or slightly dampened with water. Do not pour water directly onto the screen and do not use any type of chemical product.

7"



H= 145-150 cm

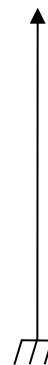

**MATERIAL NEEDED:**

- 1 skein of CAT5 Ethernet cable
- Connectors RJ45 plug
- 1 scissor
- 1 crimping tool 8-pin
- Recommended a tester for checking LAN cables

**MAKE A STRAIGHT CABLE**

PIN	Code color T568B
1	 White orange
2	 Orange
3	 White green
4	 Blue
5	 White blue
6	 Green
7	 White brown
8	 Brown

**PROCEDURE:**

- 1) SKINNING CABLE (25-30 mm)
- 2) ORDER cable as shown and line-up , cutting the connectors with scissors at the same height (about 10mm)
- 3) INSERT THE CABLE IN CONNECTOR RJ45 as shown in figure
- 4) CRIMPING WIRE with clamp
- 5) FINAL CHECK OPERATION with tester

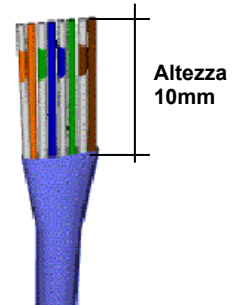
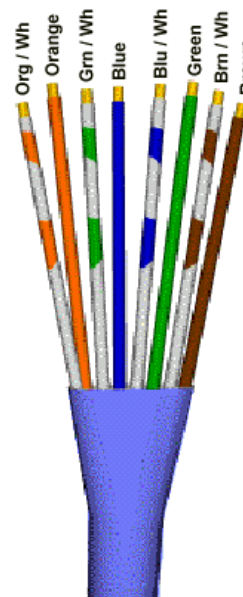
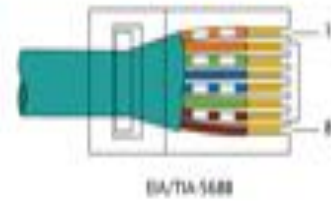
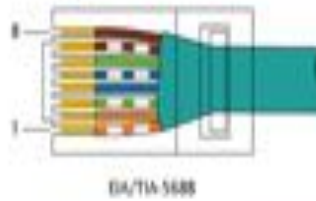

**SYSTEM PROGRAMMING**

There are two types of configurations:

- 1) Using an internal video door when you first start is recommended for small building
  - 2) For systems of higher dimensions can be a system configuration from a PC by software
- To be connected PC to any RJ45 port of InfinitePlay system by patch cords.

**IIP SETUP INSTALLER:**  
KEY PASSWORD: 000000

Setup by video door phone

**VIDEO DOOR PHONE ID ( ten digit code ):**

Building 01  
Floor 103  
Apartment 050  
Internal device 04

**PHASES OF CONFIGURATION:**

The configuration steps of the system are divided into only 5 points:

1. BASIC SETTINGS
2. ENTRANCE PANEL
3. POWER SUPPLY
4. VIDEO DOOR PHONE
5. MAPPING ENTRANCE PANEL

**1. BASIC SETTINGS**

To be programmed the basic parameters for system

- CONCIERGE ( yes / no )
- SOS PANIC BUTTON ( yes / no )
- VIDEO DOOR PHONE VISIBILITY SYSTEM( all video intercom device/ only master video intercom device )
- SYSTEM SETTING TIME (GMT 00)
- SETUP INFINITEPLAY SYSTEM LANGUAGE
- CHANGE PASSWORD OF SYSTEM ( default 000000 )

**2. ENTRANCE PANEL**

To be programmed all parameters of entrance panel in the system

IDENTIFICATION NUMBER (Mac address out door unit )= B4669800F3

CUSTOM ID NUMBER: from 1 to 200 unit

NAME ENTRANCE PANEL: Regent St

SUBTYPE: Choose the subtype of call (1-4 touch buttons, list on LCD display, buttons on LCD display )

ANSWER TIME (1 to 255 s)  
Default value 30 s

CONVERSATION TIME (1 to 255 s)  
Default value 120 s

SELF-START TIME(1 to 255 s)  
Default value 30 s

AUDIO INDOOR-OUTDOOR (0% to 100%)  
Default value 50%

ENTRANCE PANEL RINGTONE REPETITION ( yes / no )  
Default value is yes

**SAVE SETTINGS BEFORE YOU GET OUT OF SETUP**

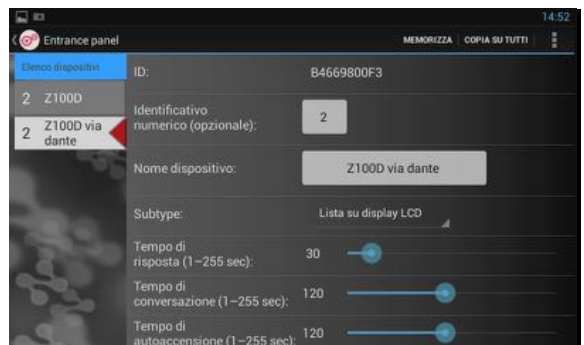
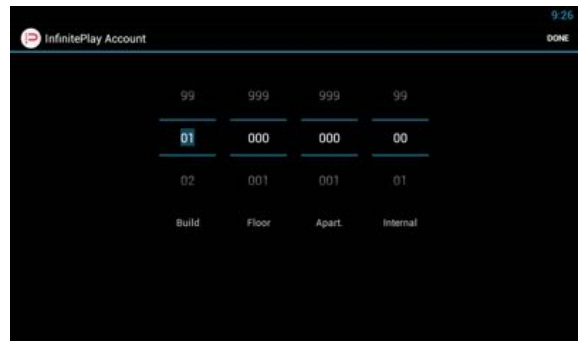
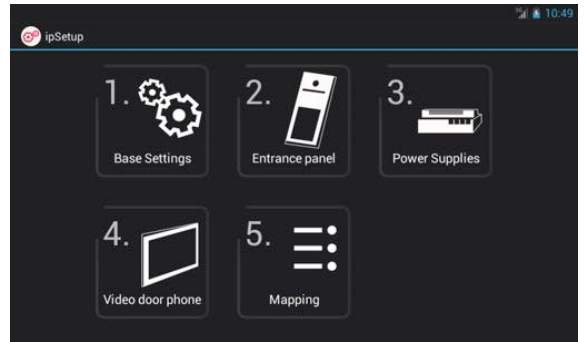
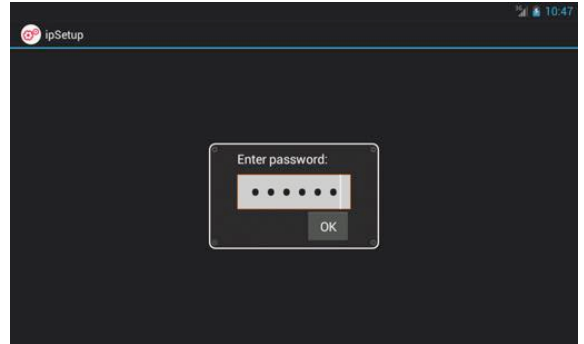

BACK

SAVE

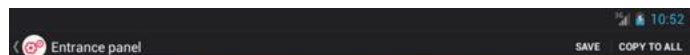

### 3. POWER SUPPLY

A video door phone INFINITEPLAY system can contain only one server SIP Z6001 and several distributors Z60DT

IDENTIFICATION NUMBER = 0000000000

DEVICE NAME: es: Z6001 Main electrical panel

#### OUTPUT

#### FUNCTION:

To be assign one of the following functions that appear in the video intercom. If you have an "X" the function is disabled.

#### CODE:

You can assign an identification number to each OUTPUT activated by outdoor unit with display. code set preceded by # symbol (eg. # 123)

#### TIMEOUT:

The time of OUTPUT can be programmed

TIME LOCK: ( from 1 to 30s ) default value 1s

TIME AUX1: ( from 1 to 30s ) default value 1s

TIME AUX2: ( from 1 to 30s ) default value 1s

TIME AUX3: ( from 1 to 30s ) default value 1s

#### ENTRANCE PANEL:

Through "entrance panel" binds the selected function to one or more entrance panel present in the system.

To a call from entrance panel will be displayed one priority function.

#### LINK:

This parameter enables indirect opening of the lock, at the same time as the opening of the lock of another entrance panel, at the command of an interphone/monitor interphone. Indirect opening can be associated with different entrance panels.

For example: LOCK type Z6001 (1) with LOCK type Z60DT (2).

When you press lock push button, will operate both entrance panel at same time by their respective power supplies.

#### INPUTS

Module type Z6001 receives the command from four N/O push button and when closing, they send the messages to output. ( ex. Light stair push button )

INPUT CALL allows you to make a call from an entrance panel to an indoor video door phone.

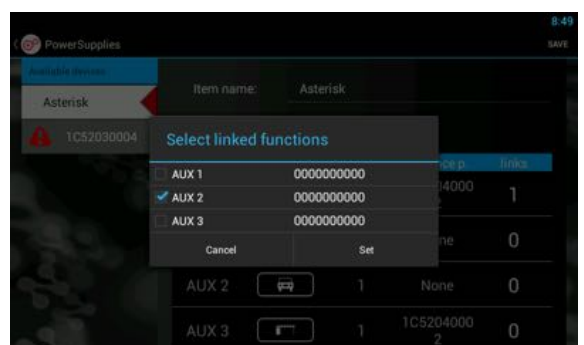
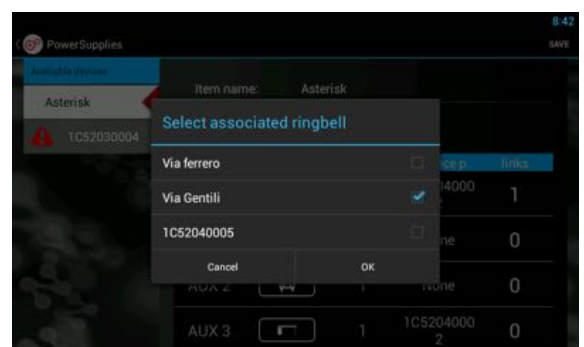
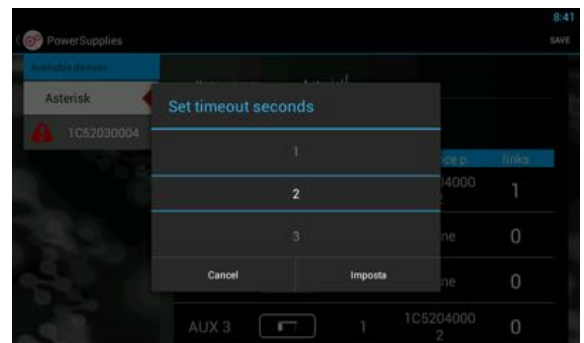
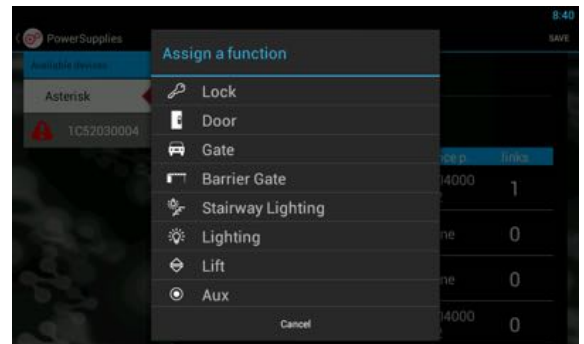
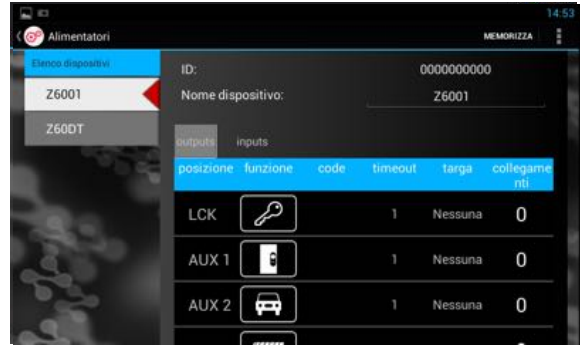

SAVE SETTINGS BEFORE YOU GET OUT OF SETUP

#### 4. VIDEO DOOR PHONE

At the first installation is requested the physical position of the device:

##### PROGRAMMING ID IDENTIFICATION CODE

Building 01  
 Floor 103  
 Apartment 050  
 Internal device 04

**In the INFINITLAY kits the monitor ID CODE :**  
01.000.001.00

##### USER NAME: (ex. Famili Briyan )

The name will appear in the display entrance panel Art.Z100D – Z200D  
 The name will appear in the intercom contacts

##### VISIBILITY ENTRANCE PANEL:

You can select the list of entrance panels that can call this device.  
 Default all entrance panels call everyone users

##### FILTER FUNCTIONS AVAILABLE:

At the request of a end user, you can disable an auxiliary function that is also used by other residents

##### VISIBILITY VIDEO DOOR PHONE:

With this function you can define the visibility of the indoor unit intercom

##### 1) INTERNAL INTERCOM CALLS

Select the list of all internal devices apartment that you can call

##### 2) EXTERNAL INTERCOM CALLS

Select the list of the internal intercom of the building that you can call

##### DOCTOR MODE: (yes/no)

When a call comes in this monitor sends the command lock automatically on power supply.

##### AUTO ANSWER: (yes / no)

By activating this function, the indoor unit will enter into conversation with the outdoor unit automatically after a few seconds

##### INTERCOM GROUPS:

With this function you can define a group of calls by choosing the origin of the call. (Eg. To join an indoor unit slave with his master)

##### 1) TO CALL FROM EXTERNAL UNIT

##### 2) TO CALL FROM INDOOR UNIT INTERNAL TO THE APARTMENT

##### 3) TO CALL FROM INDOOR UNIT EXTERNAL TO THE APARTMENT

##### ECHO CANCELLATION:

With this function you can choose the degree of noise cancellation of your INDOOR UNIT device InfinitePlay.

- 1) Normal (recommended by the factory)
- 2) hard
- 3) strong

SAVE SETTINGS BEFORE YOU GET OUT OF SETUP

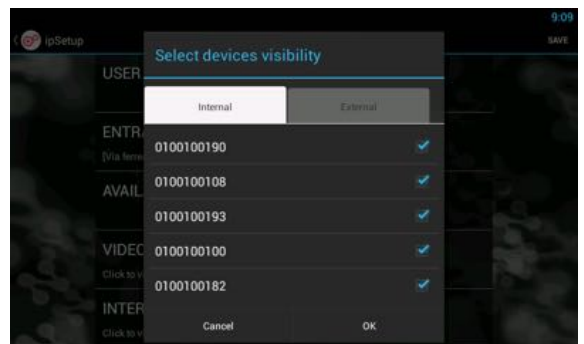
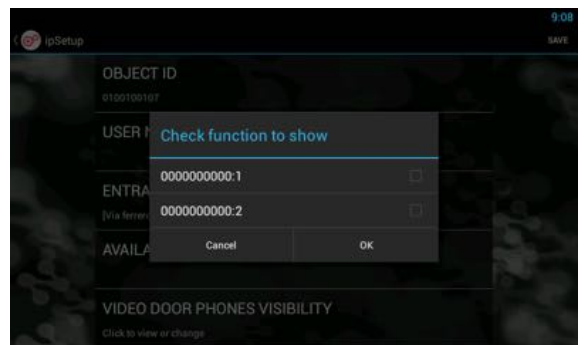
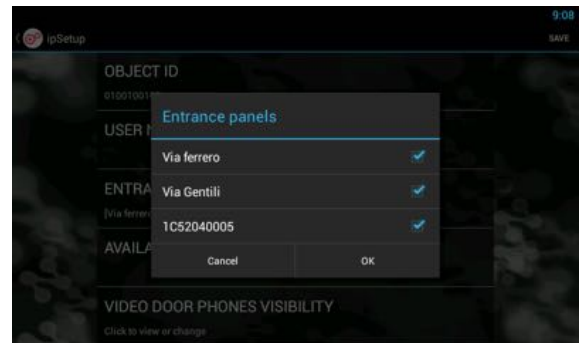
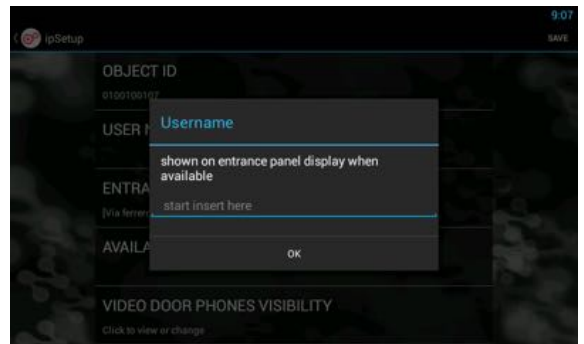
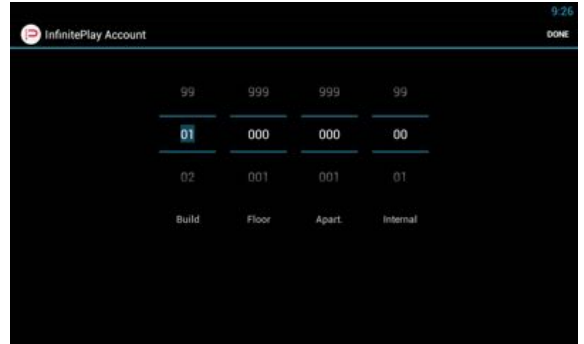

## 5. MAPPING ENTRANCE PANEL

### ENTRANCE PANEL SETUP

Select the entrance panel to set their parameters ( touch push button or display)

### ENTRANCE PANEL TOUCH BUTTONS Z1001-Z2001

If in the presence of a outdoor unit touch buttons must be set:  
TOUCH BUTTONS 1 call the indoor unit 01000001000 - Famili Briyan

### ENTRANCE PANEL TOUCH DISPLAY Z100D-Z200D

If in the presence of a outdoor unit display must be set:

**PROPERTY LOGO:** In JPG format

**PANEL RINGTONE REPEAT** (sound/ring.mp3) suggested

**VOLUME ENTRANCE PANEL** (from 0% to 100%)  
Default value 20% suggested

### STAUTS MESSAGE ( yes/no)

If you set YES the entrance panel show messages  
(Calling, in conversation, door lock opened, end the conversation)

### ENABLE ANIMATION (yes/no)

With this function activates an animation in the outdoor unit display that ease the visitor in the use of the outdoor device

### SHOW CODE BUTTON (yes/no)

Using this function enables the possibility to activate an automation from the outdoore unit by code (ex.#123)

### ENABLE RECEPTION BUTTON (yes/no)

With this function you enable a button dedicated to the call of concierge station.

**BUILDING NAME:** ( ex.Residence Argenta )

**STREET NUMBER:** ( ex. 26 ..... 2B )

**WELCOME MESSAGE**

**ALTERNATION MESSAGE**

**TIME ALTERNATION:** Settable in seconds

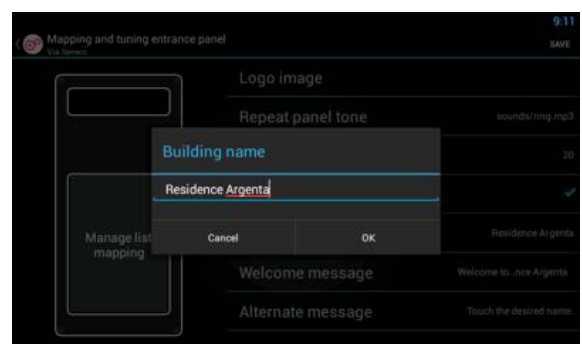
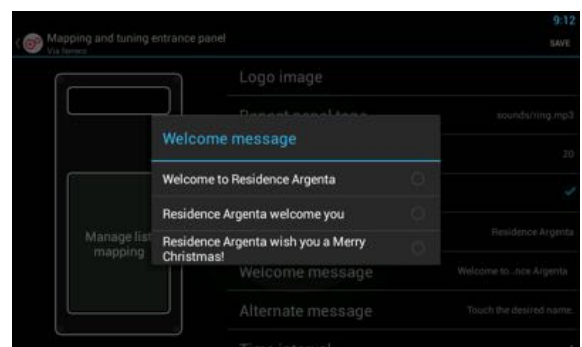
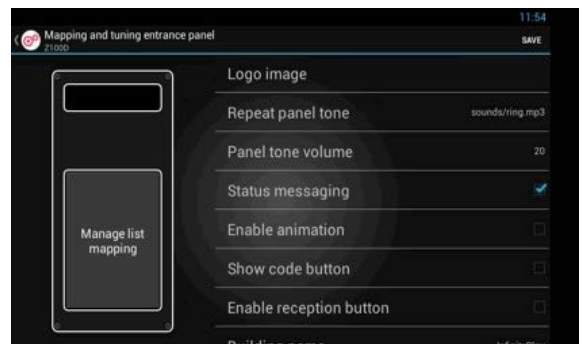
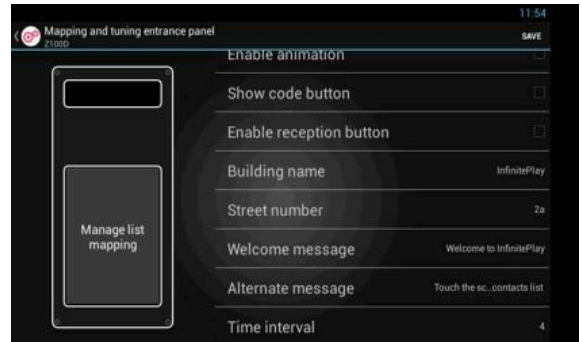
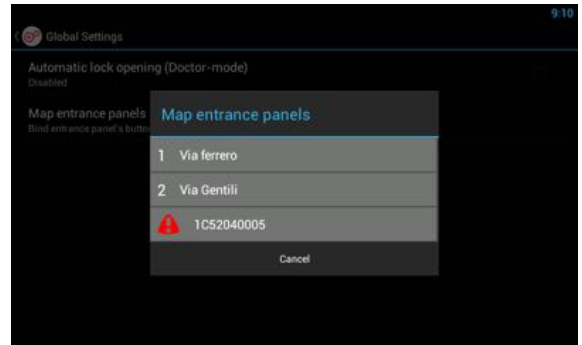

SAVE SETTINGS BEFORE YOU GET OUT OF SETUP

**OPERATING ISTRUCTIONS**

**1. FUNCTION BAR ( BUTTONS ON THE RIGHT)**

- HOME
- RETURN
- SETUP
- SEARCH

**2. VIDEO DOOR PHONE WIDGET**

- LOCK
- LIGHT STAIR
- GATE

**3. DATA AND TIME**

**4. METEO (with internet connection)**

**5. VIDEO DOOR PHONE FUNCTION**

- Available to the call (green symbol)
- Do not disturb (red symbol, choose how long)

**ANSWERING A CALL**

1. VIDEO DOOR PHONE FUNCTION
2. TO END THE CALL
3. MUTE MICROPHONE
4. TO ANSWERING A CALL

**IPCALL VIDEO DOOR PHONE APP**

1. VIDEO DOOR PHONE FUNCTION
2. CONCIERGE LIST
- INTERCOM CONTACT LIST
- ENTRANCE PANEL LIST
- LOG ACTIVITIES
3. SETUP / AUDIO SETTINGS

**MESSAGING**

TO SEND TEXT MESSAGES AND FILES ( JPG – PDF ) FROM MONITOR TO CONCIERGE AND FROM CONCIERGE TO MONITOR

THE COMMUNICATION IS ABLE BETWEEN INTERNAL MONITOR AND CONCIERGE



5 2

3  
4  
1



1

2  
3  
4



2 3

1

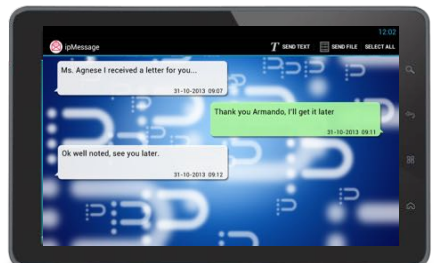



# next

## OPERATION:

Important: For the monitor operation, the ID must have already been programmed. To check this, in all devices

### Operating times

The answer and the conversation times depend on the configuration of the corresponding entrance panel parameters.

- Answer time (for entrance panel call): Default value 30 s
- Answer time (for intercommunicating call): 30 s
- Conversation time (for entrance panel call): Default value 120 s
- Self-activation time (for entrance panel call): Default value 30s

### Answering a call

A call from the outdoor entrance panel or from an intercommunicating device can be answered during the chime cycle or once it has ended. To answer, press green push button; to end the call, press red push button.

### Receiving a door call

The monitor can receive calls from a door call button if connected to terminals M and FP directly. When the door call button is pressed, the monitor emits a different tone to the one used for outdoor entrance panel calls or intercommunicating calls.

### Making an intercommunicating call

To make a call to another indoor unit, it is necessary to open the videodoor phone app and choose the name to the contacts list.

### Muting the ringtone during a call (Mute function)

When receiving a call from an outdoor entrance panel or from an intercom device, the call ringtone can be muted by pressing button MUTE in home page widget. You can set the mute time ( for example 30 minutes )

### Door lock command

If you press the lock button by home page widget to send a lock opening command to the entrance panel. The lock is connect to the power supply for security

### Self-start

The videodoor phone is able to recognize the entrance panel or CCTV cameras.

From the entrance list you can make a self-start function for monitoring and conversation.

### Calling a concierge station

Form the concierge list you can call the concierge service ( lobby, management office, guard office)

### Alarm and Panic buttons

The monitor can sand two alarms to Concierge station  
Connecting a button dirctly to terminals M and AL, you can sand an alarm ( gas detector, smoke detector ) to concierge  
If connecting a button dirctly to terminals M and P, you can sand an panic alarm to concierge . This function is able from widget SOS

### Choice a ringtone

Through the settings you can choose between different electronic ringtone.

### Ringtone volume adjustment

Through the settings you can choose between different volume levels plus mute.

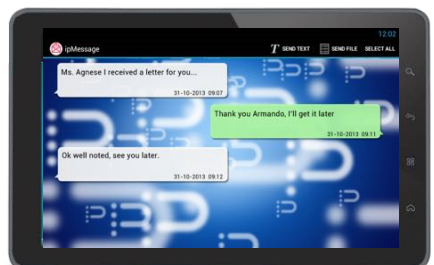

SINGLE RESIDENCE SYSTEM WITH 7" VIDEO DOOR PHONE AND ONE AUDIO-VIDEO ENTRANCE PANEL



Video door phone

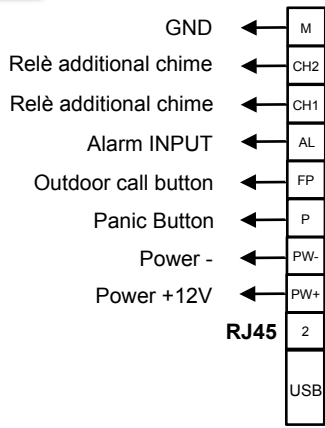

Entrance panel

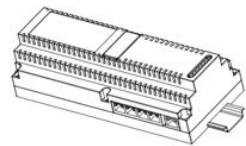
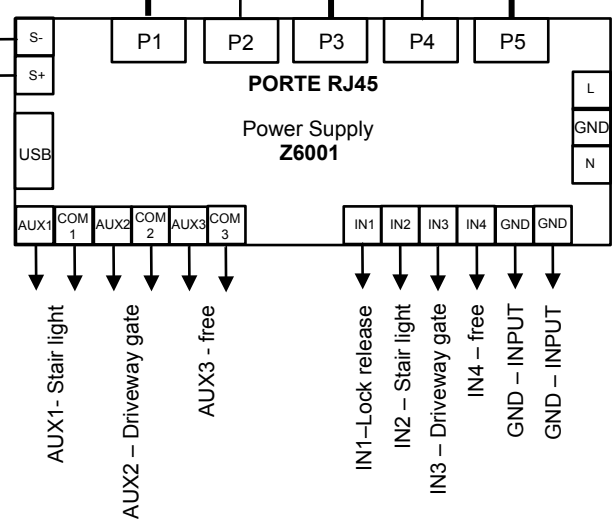
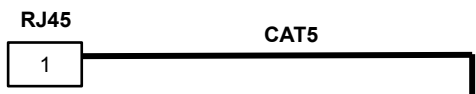

Conductor section

Terminals	Up to 100mt
1,2,3,4,5	RJ45
Cable	CAT 5
Lock	1,5 mm2
Other	1 mm2

DOUBLE RESIDENCE SYSTEM WITH 7" VIDEO DOOR PHONE AND ONE AUDIO-VIDEO ENTRANCE PANEL



Video door phone 2



Video door phone 1



Entrance panel

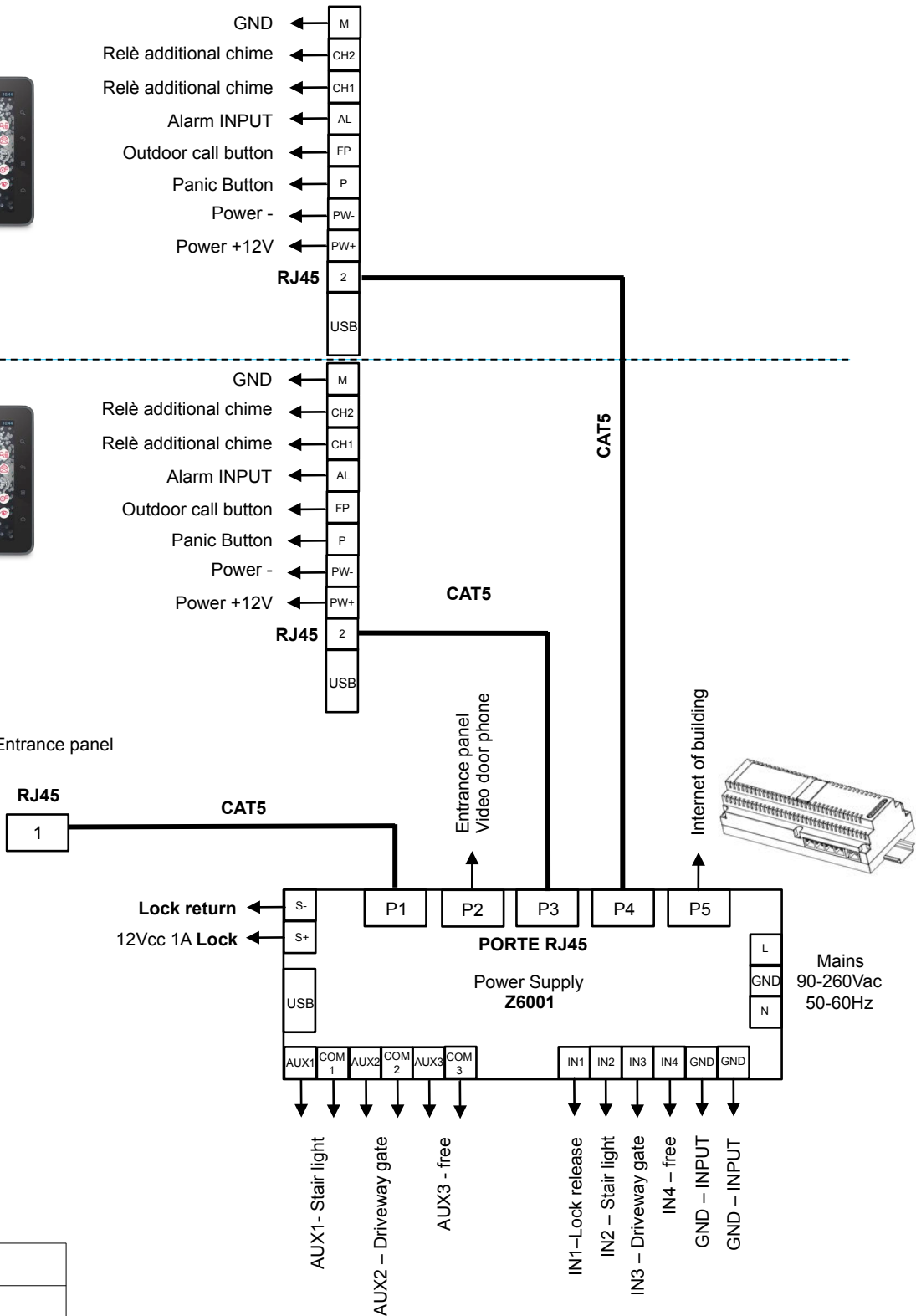

Conductor section

Terminals	Up to 100mt
1,2,3,4,5	RJ45
Cable	CAT 5
Lock	1,5 mm2
Other	1 mm2

DOUBLE RESIDENCE SYSTEM WITH 1 VIDEO DOOR PHONE, 2 VIDEO DOOR PHONES WITH INTERNET CONNECTION AND ONE AUDIO-VIDEO ENTRANCE PANEL WITH TWO PUSH BUTTONS

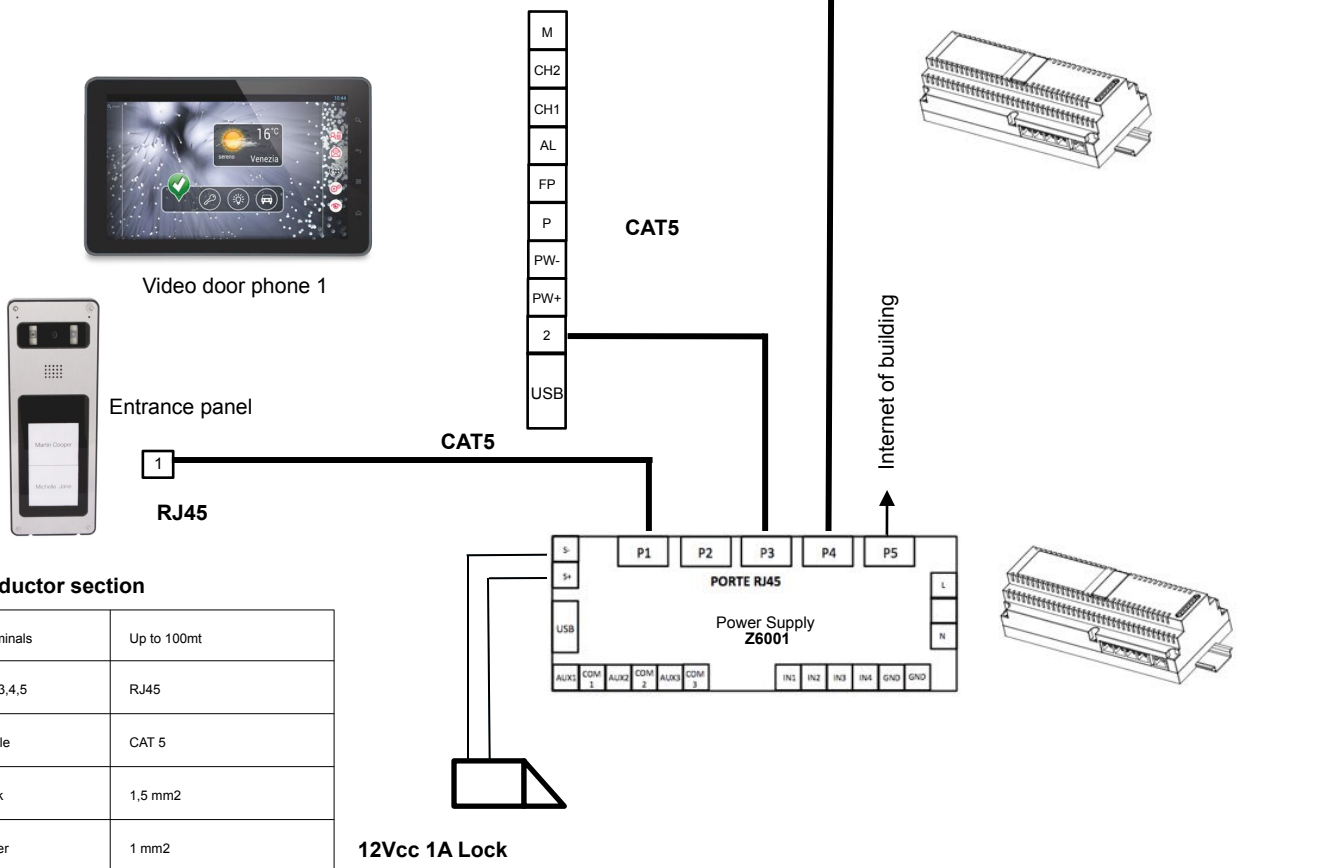
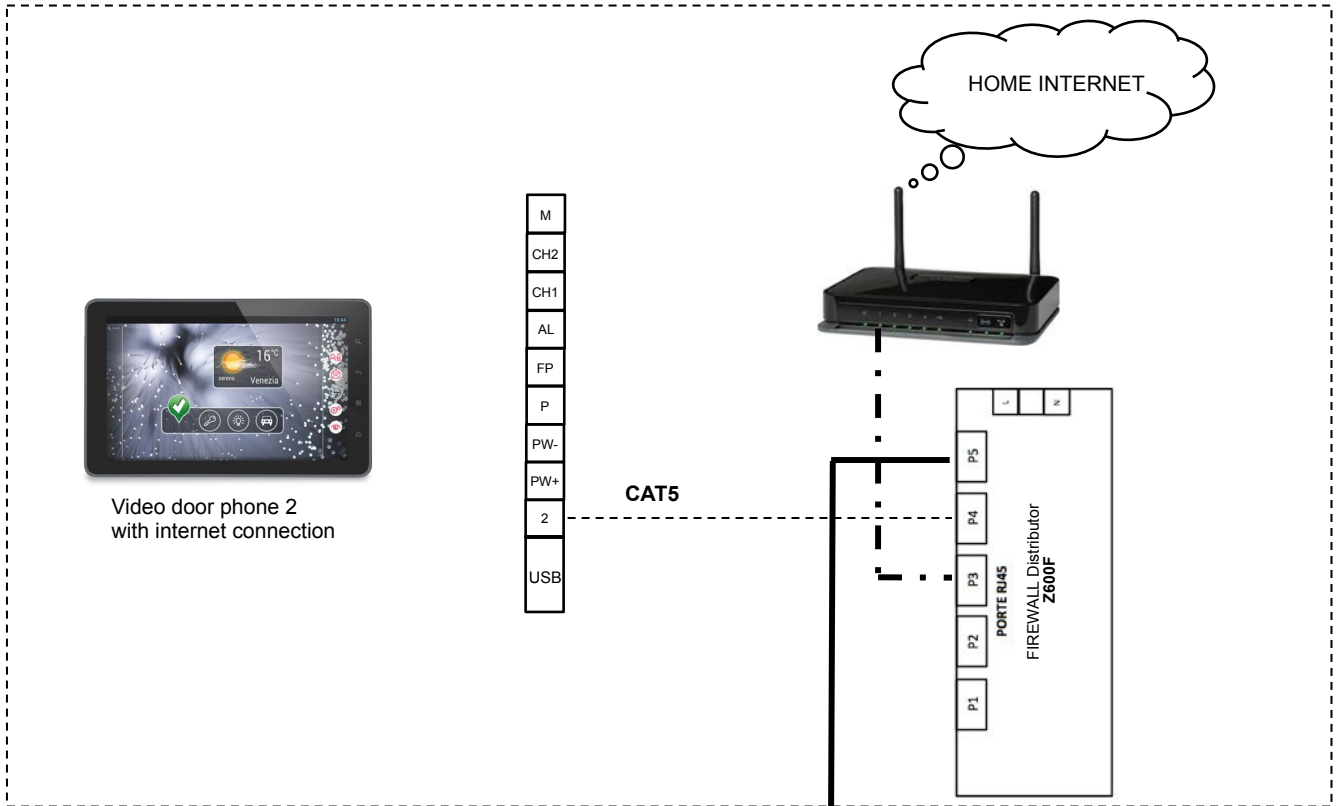

**Conductor section**

Terminals	Up to 100mt
1,2,3,4,5	RJ45
Cable	CAT 5
Lock	1,5 mm2
Other	1 mm2

12Vcc 1A Lock

MULTIPLE RESIDENCE SYSTEM WITH ONE AUDIO-VIDEO ENTRANCE PANEL, POWER SUPPLY, DISTRIBUTOR AND 12 VIDEO DOOR PHONES



Video door phone



Video door phone



Entrance panel

1  
RJ45



CAT5

CAT5

Video door phone

Video door phone

CAT5

Internet of building

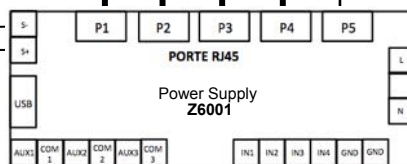
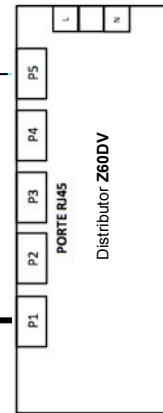
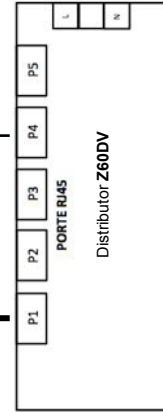
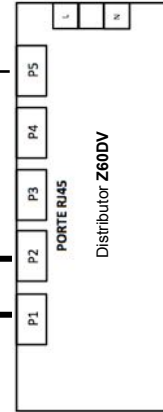

12Vcc 1A Lock

Conductor section

Terminals	Up to 100mt
1,2,3,4,5	RJ45
Cable	CAT 5
Lock	1,5 mm2
Other	1 mm2

BUILDING COMPLEX SYSTEM WITH TWO AUDIO-VIDEO ENTRANCE PANELS, POWER SUPPLY, CONCIERGE STATION AND DISTRIBUTOR



Video door phone

Entrance panel



12Vcc 1A Lock

12Vcc 1A Lock



Video door phone

CAT5

CAT5



CONCIERGE

CAT5



Power Supply Z6001

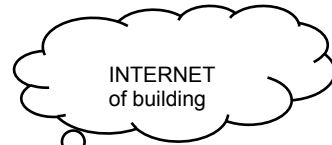
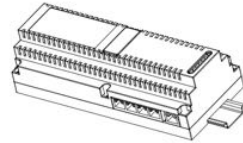
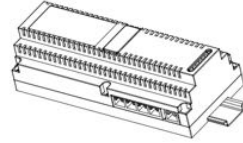
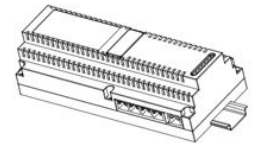
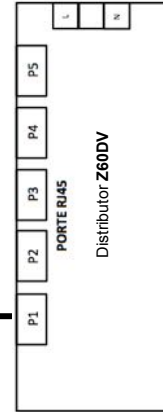
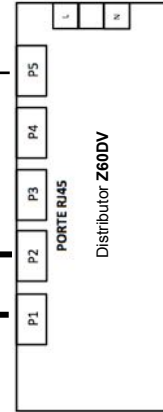

INTERNET of building

Conductor section

Terminals	Up to 100mt
1,2,3,4,5	RJ45
Cable	CAT 5
Lock	1,5 mm2
Other	1 mm2

CONNECTION VARIANTS:

WIRING DIAGRAM ADDITIONAL ELECTRONIC CHIME



Video door phone

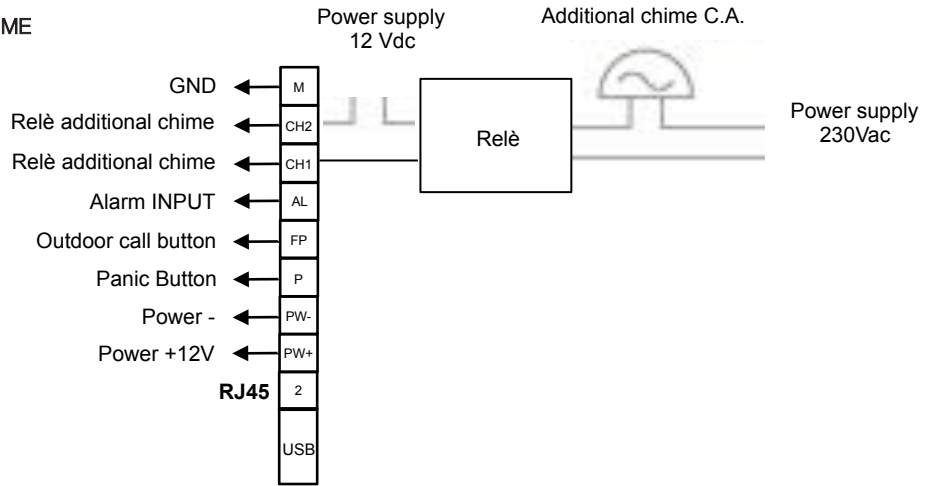

Video door phone

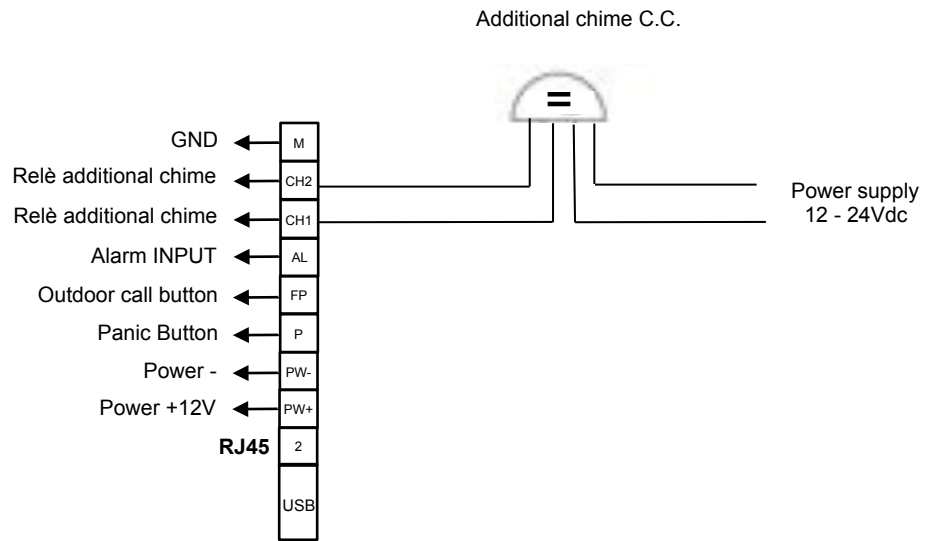

WIRING DIAGRAM DOOR CALL BUTTON



Video door phone

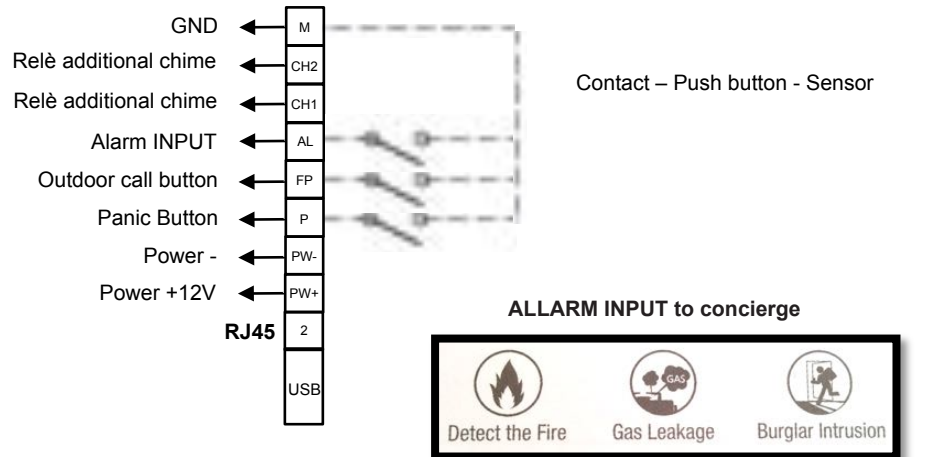

CONNECTION VARIANTS:

WIRING DIAGRAM DOOR RELESE CONTROL

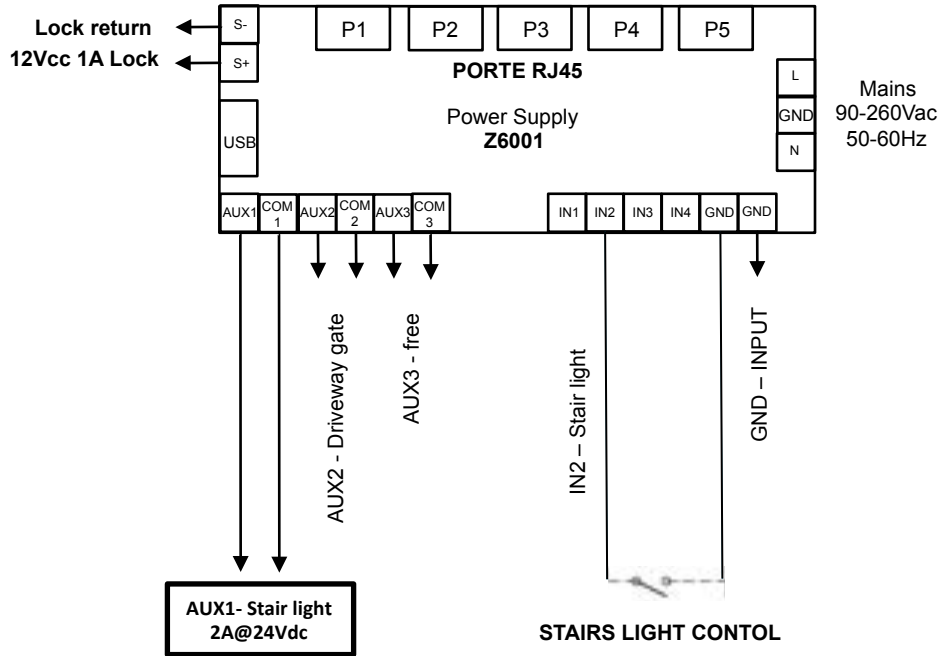

WIRING DIAGRAM DOOR RELESE CONTROL

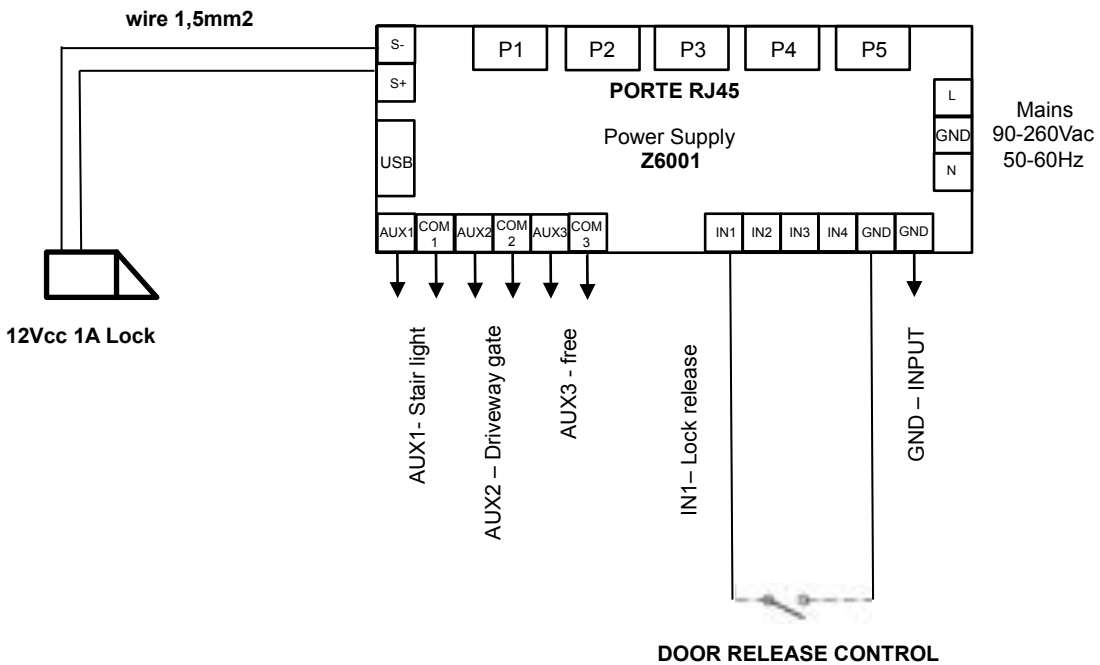



# next

---

INSTALLATION NOTE :

# next

---

INSTALLATION NOTE :

**Directive 2012/19/UE (WEEE)**

The crossed-out wheelee bin symbol marked on the product indicates that the product must be assigned to a differentiated collection centre for electrical and electronic equipment or returned to the dealer to purchase a new product.

For further details regarding the collection systems available, contact your local waste disposal service.

The user is responsible for assigning the equipment purchased, to the appropriate collection facilities.

**Risks connected to substances considered as dangerous (WEEE).**

According to the WEEE Directive, these electrical and electronic products contain harmful substances for people and the environment.

It is obligatory treat the recycling of the materials in such way to avoid negative impacts on the environment and people's health.

Adaptation to current regulations allows a correct recycling of which the product is made.



**SAFETY INSTRUCTIONS FOR INSTALLERS**

This equipment is used in video door entry and home & building automation systems.

The instructions in this document provide important information about safety, installation, use and maintenance of the product.

Verify that the equipments are undamaged, after purchase.

The packaging contains potential dangerous sources for children (screws and dowels).

The installation must respect the current CEI regulations.

It is necessary to install to the power supply a protection bipolar type switch to video door entry system.

Before connecting this equipment verify the output voltage supplied from the distribution network.

Before performing maintenance operations, disconnect the device.

In case of failure or malfunction, disconnect the device and contact the technical assistance centre.

Do not obstruct opening of ventilation or heat exit slots.

The protection bipolar type switch must be located in the main framework of the House.

**WARNING:**

This equipment must be fixed to the wall according to the installation instructions.

This leaflet must always be attached to the system documentation.



Product is according to EC Directive 2004/108/EC, 2006/95/EC and following norms.



INFINITEPLAY



Via Monte Grappa, 25  
31020 Villorba (TV) ITALY  
Tel. 0422 350680  
Fax. 0422 446958  
[www.infiniteplay.com](http://www.infiniteplay.com)



ENG  
18901004 - RL00 01 14  
ZEALABS - ITALY