

theben

TR

TR 635 top2 6350100

TR 636 top2 6360100

Installation and operating instructions

Digital time switch
with weekly program



309563 03

GB

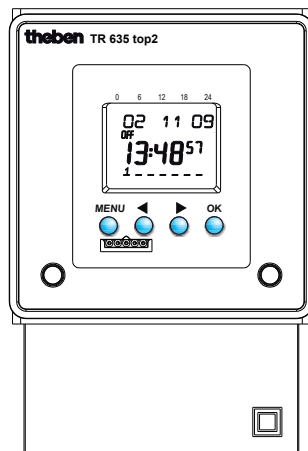

TR 635 top2

Connection of
different external
wires is permitted

Contents

Basic advice	3	Menu item OPTIONS	
Screen and keys	4	PIN code setting	14
Operating instructions	4		
Overview of menu selection	5	OBELISK top2 memory card	15
Connection/installation	6	Service address/Hotline	15
Initial start-up	8	Technical data	16
Reset	8		
Menu item PROGRAM			
Set switching time	9		
Change/request switching time	11		
Delete switching time	11		
Pulse programming	12		
Cycle programming	13		
Menu item MANUAL			
Manual and permanent switching	14		

Basic safety instructions



WARNING

Danger of death through electric shock or fire!

- Installation should only be carried out by a qualified electrician!

- The device is intended for wall and front panel installation
- Corresponds to type 1 BSTU in accordance with IEC/EN 60730-2-7
- Power reserve (10 years) is reduced if memory card is inserted (in battery operation)

Designated use

- The time switch can be used for lighting, bell systems, ventilation etc.
- Only use in enclosed dry spaces
- Do not use on safety devices, e.g. escape route doors, fire safety equipment etc.

Disposal

Dispose of device separately in an environmentally sound manner

Screen display and keys

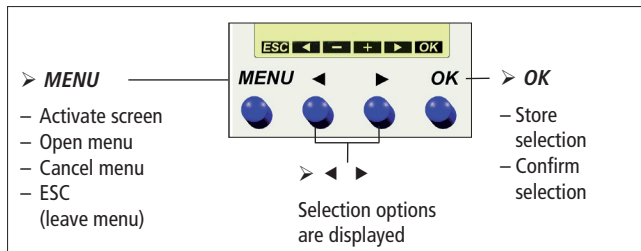
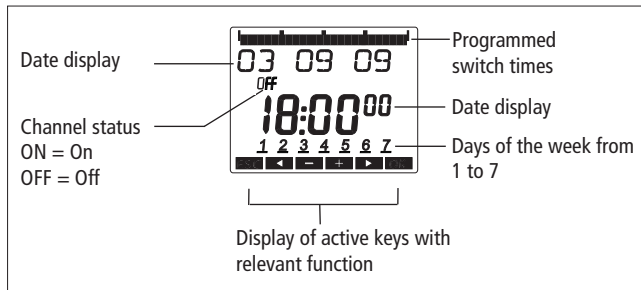

Operating instructions

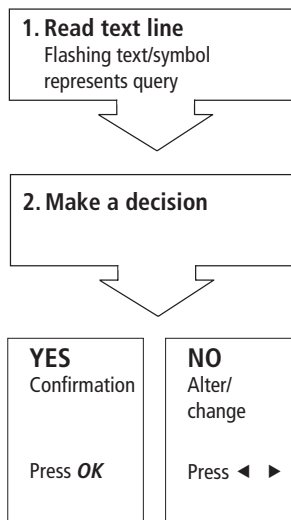

Overview of menu selection

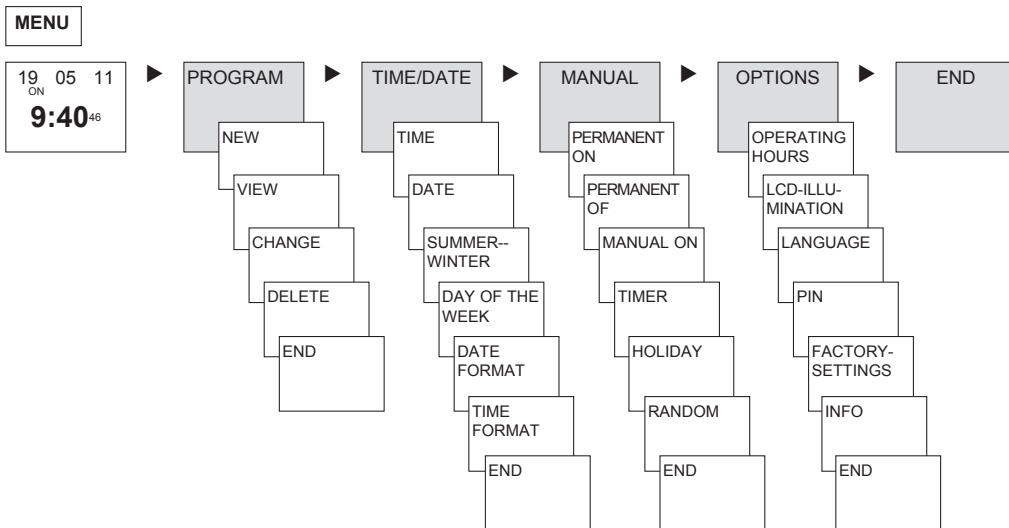

Connection

 **WARNING**



Warning, danger of death through electric shock!

- Must be installed by qualified electrician!
- Disconnect power source.
- Cover or shield any adjacent live components.
- Ensure device cannot be switched on!
- Check power supply is disconnected.
- Earth and bypass.

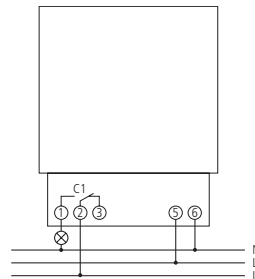

TR 635 top2

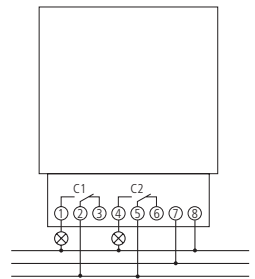

TR 636 top2

Installation

Distributor installation (wall)

- for installation on DIN top hat rails (in accordance with EN 60715) with accessories (9070071)

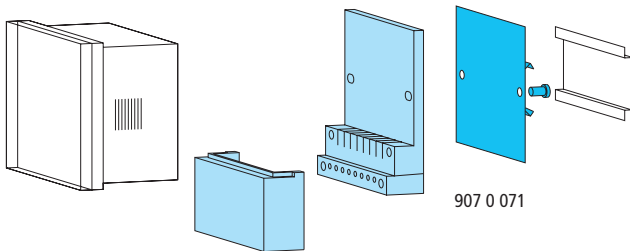

Front panel installation

- for installation in front frame and transparent cover (in accordance with DIN 43700)

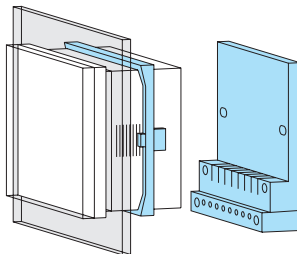

Initial start-up

Set date, time and summer/
winter time rule

- Press required key and display follows on screen (see figure).

RESET

- Press the 4 buttons simultaneously.

You can choose between **RETAIN PROGRAMS** and **DELETE PROGRAMS**.

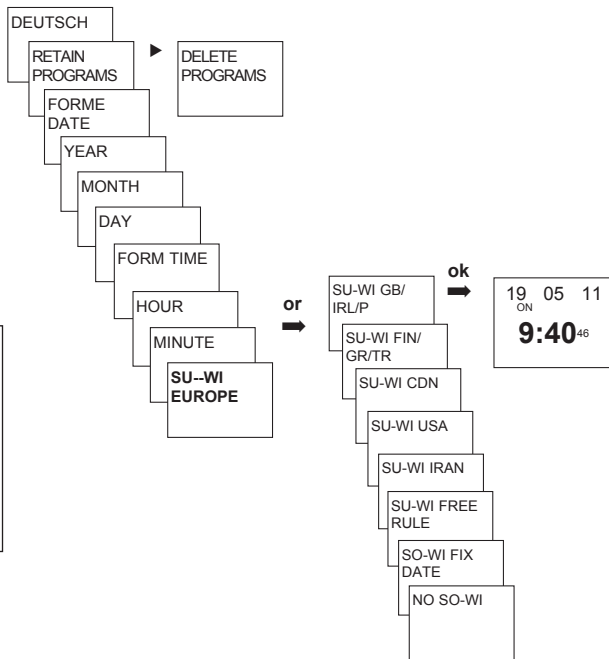

PROGRAM

Program switching time

Example: Switch on sports hall lighting from Mon–Fri, 7:30 to 12:00 hrs

- Press **MENU**. **PROGRAM** is displayed.
- Confirm by pressing **OK**. **NEW** is displayed.
- Confirm by pressing **OK**. **SWITCHING TIME** is displayed.
- Confirm by pressing **OK**. Select **ON** (for switch-on times).
- Confirm by pressing **OK**. The display shows **HOUR**.
- Use the + or – keys to enter hour, minute, (07:30) and confirm by pressing **OK**.
MONDAY is displayed.
- Confirm by pressing **OK**. **COPY** is displayed.
- Confirm by pressing **OK**. **ADD TUESDAY** is displayed.
- Confirm by pressing **OK** and also confirm the days Wed, Thurs, Fri by pressing **OK**.
- Continue with ► to **SAVE** is displayed. Confirm by pressing **OK**.

Repeat all steps for the switch-off time however instead of selecting ON with ► select OFF and enter 12:00 for hour and minute.

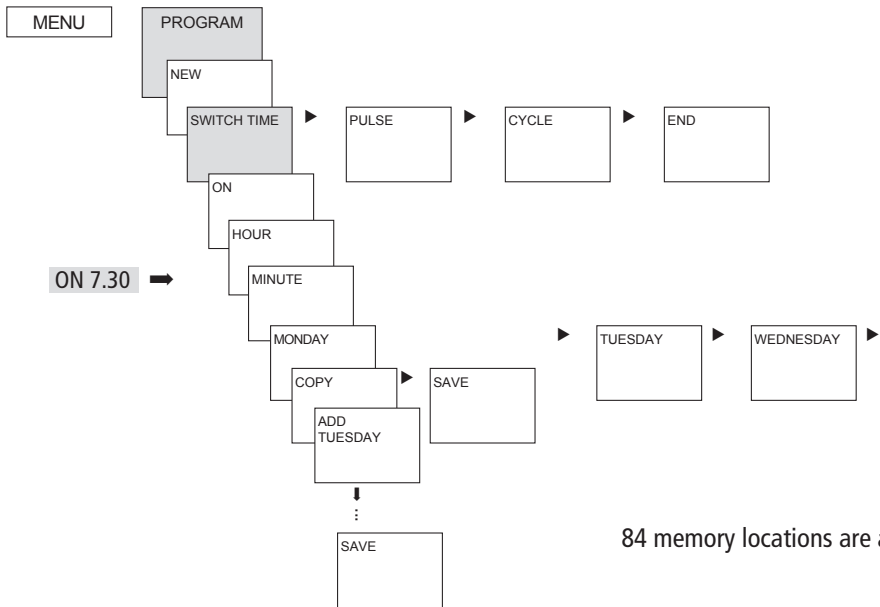

Request/change/delete switching time

- Press **MENU**. **PROGRAM** is displayed.
- Confirm by pressing **OK**. **NEW** is displayed.
- Use **▶** to select **CHECK**.
- Confirm by pressing **OK**.
- Confirm **SWITCH TIME** by pressing **OK**.
The first of the entered switching times is displayed.
- Confirm by pressing **OK**. **NEXT** is displayed.

Change or delete individual switching times

- Press **▶** to select **MODIFY** (or **DELETE**).
- Confirm **MODIFY HOUR** by pressing **OK**.
- Confirm by pressing **OK**. The first of the entered switching times is displayed.
- Use the **+** or **-** keys to enter hour and minute and confirm by pressing **OK**.

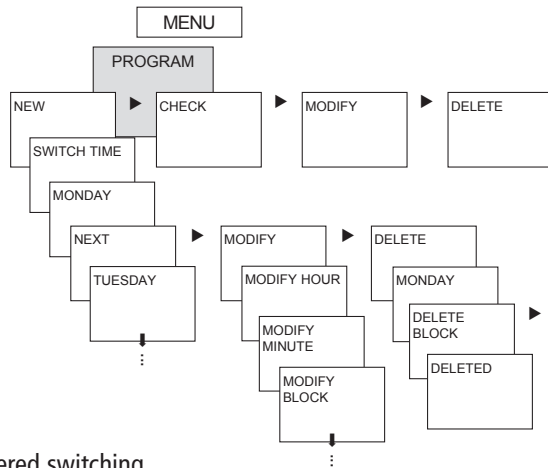

Pulse time programming

Example: Switch on pause signal on Monday 8:05 hrs for 5 sec

- Press **MENU**. **PROGRAM** is displayed.
- Confirm by pressing **OK**. **NEW** is displayed.
- Confirm by pressing **OK**. **SWITCH TIME** is displayed.
- Select **PULSE** by pressing **▶**.
- Confirm by pressing **OK**. **ON** is displayed.
- Confirm by pressing **OK**. The display shows **HOUR**.
- Use the + or – keys to enter hour, minute, second (8:05) and confirm by pressing **OK**. **PULSE LENGTH** is displayed.
- Use the + or – keys to enter the duration of the pulse in minutes and seconds (5 sec). **MONDAY** is displayed.
- Confirm by pressing **OK**. **COPY** is displayed.
- Press **▶** to select **SAVE**.
- Confirm by pressing **OK**.

Cycle time programming

In addition to switch-on and switch-off times (switching time) and short time pulses (pulse) cycle times (cycle) can also be programmed. The pulse length (+ pulse pause) is limited to 17 hrs, 59 min, 59 sec

- Cycle times refers to cyclically repetitive time functions such as fan controls, urinal rinses etc.

Example: Switch on water rinsing Monday from 8:00 to 20:30 hrs every 15 min for 20 sec (8:00⁰⁰–8:00²⁰ On; 8:15⁰⁰–8:15²⁰ On; 8:30⁰⁰–8:30²⁰ On etc.)

Cycle programming

- Start cycle: Monday 8:00 hrs
 - Pulse length: 20 sec
 - Pause length: 14 min 40 sec
 - Cycle end: Monday 20:30:00 hrs
- Observe the number of maximum electrical switching cycles when using the ,cycle' function.

Manual and permanent switching

Manual and permanent switching can be set using the menu in **MANUAL** or (in the automatic screen) by key combination (see fig.).

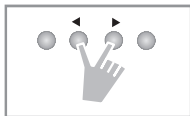

Activate manual switching

- Briefly press both keys simultaneously.

Activate permanent switching

- Simultaneously press both keys for 2 seconds.

Cancelling manual/permanent switching

- Press both keys simultaneously.

Enter PIN code

The **PIN code** can be set using the **OPTIONS** menu item (see fig.). If you forget the PIN call the Theben hotline.

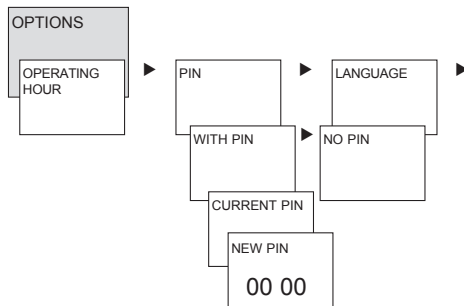

OBELISK top2 memory card

Use memory card

- Insert memory card in the time switch.
- Read / read out saved switching times and device settings in the time switch or start Obelisk program.
- Remove memory card OBELISK top2 (No. 9070404) after copying.
- Avoid mechanical stress or dirtying with other storage/transport methods.

Serviceadresse/Hotline

GB

Service address

Theben AG

Hohenbergstr. 32

72401 Haigerloch

GERMANY

Telephone +49 (0) 74 74 6 92 0

Fax +49 (0) 74 74/6 92-150

Hotline

Telephone +49 (0) 74 74 6 92 -369

Fax +49 (0) 74 74/6 92-207

hotline@theben.de

Addresses, telephone numbers etc.

www.theben.de

Technical data

- Operating voltage: 230–240 V~, +10 %/-15 %
- Frequency: 50–60 Hz
- Power consumption: 0,8 W (TR 635 top2),
0,9 W (TR 636 top2)
- Standby: 0,9 W (TR 635 top2),
1,1 W (TR 636 top2)
- Switch output: switching of choice of
external wires is permitted
- Contact: two way switch
- Gap: <3 mm (μ)
- Contact material: AgSnO_2
- Max switching capacity: **TR 635 top2:**
16 A, 250 V~, $\cos \varphi = 1$
10 A, 250 V~, $\cos \varphi = 0,6$
TR 636 top2:
6 A, 250 V~, $\cos \varphi = 1$
6 A, 250 V~, $\cos \varphi = 0,6$
- Min. switching capacity: 10 mA/230 V AC
100 mA/12 V AC/DC
- Incandescent lamp load + Halogen lamp load:
2300 W (TR 635 top2)
1200 W (TR 636 top2)
- Fluorescent lamp load: uncorrected +
(VVG) series corrected 1000 VA
parallel correction 400 VA (42 μ F)
- Compact fluorescent lamps: 90 W
- LED lamps: <2 W output, max. connec-
tion total of 20 W,
>2 W < 8 W output, max.
connection total of 50 W
- Permissible ambient temperature: -30 °C ... +55 °C
- Protection class: II in accordance with
EN 60730-1 subject to
designated installation
- Protection rating: IP 20 in accordance with
EN 60529
- Time accuracy: $\leq \pm 0,5$ s/day at +20 °C
- Power reserve: 10 years (lithium cell) at +25 °C
- Pollution degree: 2
- Rated impulse withstand voltage: 4 kV
- TR 635 top2: max. switching cycles with
16 A resistive load: 50,000
- TR 636 top2: max. switching cycles with
6 A resistive load: 50,000