

Solar RPTS Q553 24 Hour, 4-pin Time Switch with 1 or 2 ON/OFF Operations with 100 Hour Battery Reserve



Benefits

Q553 Solar Dial quartz controlled with battery reserve and day omission, 4 pin base.

- .13 version, gives one ON and one OFF operation per day.
- .14 version, gives two ON and two OFF operations per day.

The ON operation always tracks SUNSET while the OFF operation can be made either to track SUNRISE, or to occur at a fixed time between 8:30pm and 1:00am.

The Q553 comes in 4 separate 'Zones' relating to your latitude, see reverse for map.

The Solar Time Switches are ideal for applications which require control linked to sunset and sunrise times. Popular applications for solar time switches include street, stairwell and security lighting.

Once set, the switches track SUNSET and SUNRISE throughout the year, without the need to sense light levels. This avoids the installation and maintenance problems associated with photo sensing devices and means they can be left to operate unattended for years.

Dimensions

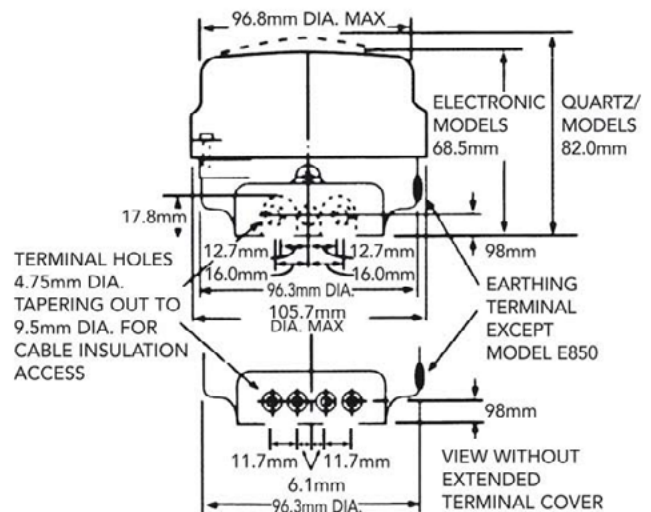
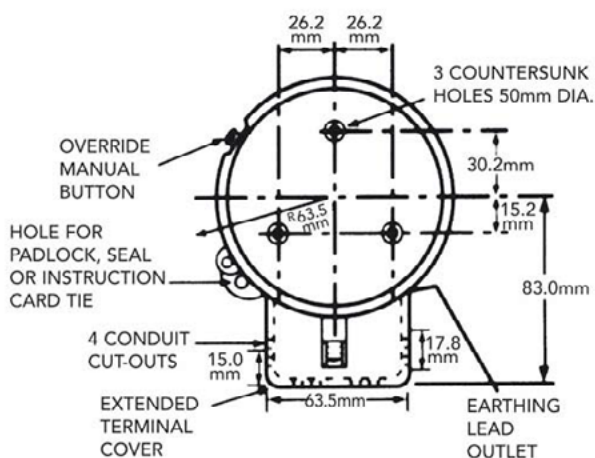

Technical Data

<i>Programming</i>	<i>24 hour programme with 1 or 2 ON/OFF operations per day</i>
<i>Display</i>	<i>Solar dial</i>
<i>Mounting</i>	<i>Surface mounting</i>
<i>Current Rating</i>	<i>SPST: 20amp resistive</i>
<i>Supply</i>	<i>230V, 50/60 Hz a.c.</i>
<i>Base Type</i>	<i>4 Pin</i>
<i>Reserve</i>	<i>100 hrs (providing battery has been charged for 300 hrs)</i>
<i>Day Omission</i>	<i>none</i>
<i>Temp Override Facility (Manual Button)</i>	<i>Advance to "OFF", when program "ON" and will remain "OFF" unit next "ON" operation and vice versa</i>
<i>Cable Size</i>	<i>6.0mm²</i>
<i>Timing Accuracy</i>	<i>5 mins/year</i>
<i>Power Consumption</i>	<i>0.6W at 230V</i>
<i>Ambient Temperature Range</i>	<i>Designed to operate over a temperature range of 0°C to 50°C continuous</i>
<i>Live Parts Protection</i>	<i>This timer is totally protected by its enclosure</i>
<i>Dirt Protection</i>	<i>Normal domestic dust deposits only</i>
<i>Moisture Protection</i>	<i>Ordinary: has no special protection against moisture</i>
<i>Shock Protection</i>	<i>Class 1 (Product must be earthed)</i>
<i>Dial Calibration</i>	<i>15 min divisions</i>
<i>Setting Accuracy</i>	<i>+/- 3 minutes</i>
<i>Conforms To</i>	<i>BS EN60730</i>
<i>Dimensions</i>	<i>Height (wall mounted) 136mm, width 105.7mm, projection 82mm, (Total height 146.5mm)</i>

Electrical Connections

Internal Wiring Diagram

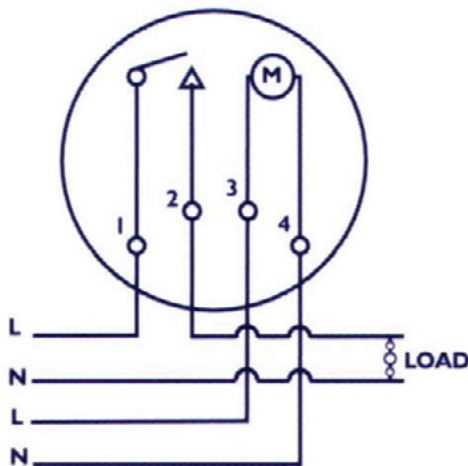

UK Solar Map

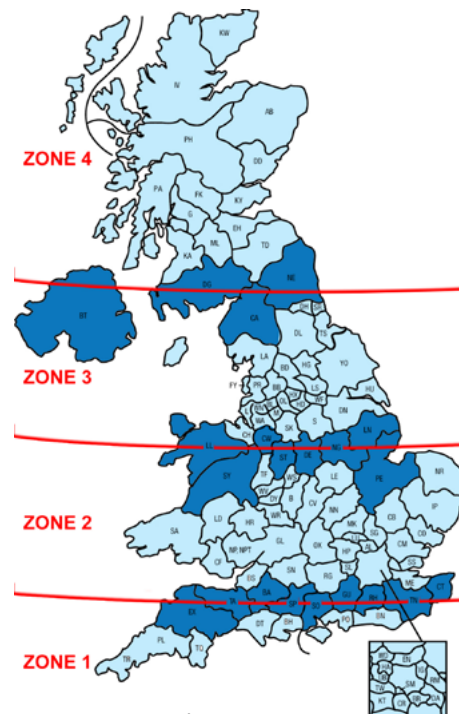

Contact Us: 01475 745131

CUSTOMER CARE POLICY

As part of Sangamo's continuous improvement program, the Company operates a Customer Care Policy. This means that we welcome your comments and complaints, as it can only help us to improve our services to you, our customer.

SANGAMO

Sangamo Limited, Industrial Estate, Port Glasgow,
Renfrewshire PA14 5XG

Tel: 01475 745131 Fax: 01475 744567

Email : enquiries@sangamo.co.uk Web: www.sangamo.co.uk