

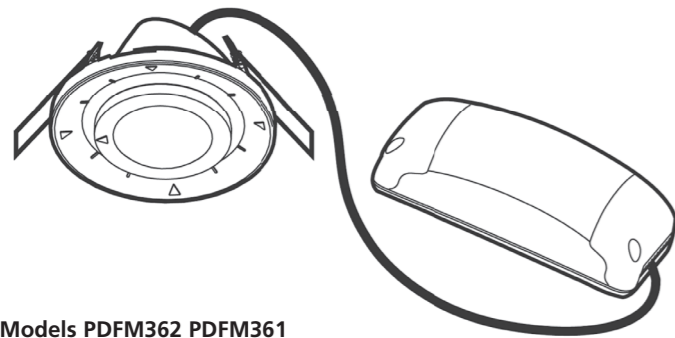

Conforms To EC Directives



Flush Mount Presence Detector PDFM362/PDFM361 Instructions



Models PDFM362 PDFM361

Technical Specifications

Rated Voltage: 230V ~ ±10% 50Hz

Loads:

This product must be protected by a fuse or circuit breaker with a maximum rating of 10A or lower.

PDFM362:
 Load I (L1) for Lighting: μ contact gap
 Mains halogen lamp: max. 1000W
 Incandescent lamp: max. 2000W
 LV halogen lamp: max. 600VA
 Fluorescent lamp: max. 900VA/100 μ F
 LED lamp: max 400W
 Load II (D1-D2) for HVAC:
 Voltage free contacts:
 Max. 5A for 250V AC~ or 30V DC (resistive)
 Motor: 1/10HP (approx. 73W)

PDFM361:
 Load I (L1) for Lighting: μ contact gap
 Incandescent lamp: max. 2000W
 Mains halogen lamp: max. 1000W
 LV halogen lamp: max. 600VA
 Fluorescent lamp: max. 900VA/100 μ F
 LED lamp: max 400W

Delay Time Adjustment:

PDFM362:
 TIME1 (for lighting):
 Adjustable from 5 sec. to 20 min. (continuously adjustable)
 Extendable to 30 min. and 60. min when in use with the IR10 remote control
 TIME2 (for HVAC):
 Continuously adjustable from 10 sec. to 60 min. (independent of light level)

LUX (light level) Adjustment:
 Adjustable from 10 LUX to 2000 LUX (continuously adjustable)

Max. Detection Coverage: 360° cone shape from ceiling height of 2.5m giving 7m dia. coverage at floor level (for affect of ceiling height on coverage see section 3.1.1)

METER Adjustment: Adjustable continuously from + giving maximum detection coverage at floor level to – giving substantially reduced detection coverage at floor level

Connection between Sensor and Power Unit: 1m flying lead from sensor terminated in an RJ11 plug. RJ11 socket on power unit (use socket A for PDFM362)

Operating Temperature: 0°C to +45°C

Environmental Protection: Sensor: IP40
Power unit: IP20

All procedures indicated in this manual must be carried out by a professional installer.

1 Package Contents

Visual I.D.				
Item	Sensor	Power Unit	Instructions	IR10 (optional purchase)
Quantity	1	1	1	

2 Product Description

2.1 Features

The PDFM362 PDFM361 controller is a ceiling flush mount presence detector for indoor applications in commercial and domestic locations. PDFM361 covers lighting applications only, whereas PDFM362 can control lighting and HVAC (heating, ventilating and air conditioning) applications. Adjustment of Time and LUX value can be made either by the dial controls on the sensor body or by the IR10 Infrared remote control.

- PDFM362 has two relays for outputs load I and load II: load I is for lighting control and load II has voltage free contacts for HVAC control which operate at all LUX (light) levels.
- Automatically adjusts to fit in a wide range of ceiling thicknesses.
- The sensor has a very high density of sensitive beams covering the detection area. These are evenly distributed ensuring no dead spots and detection of the smallest movements.
- RJ11 plug and socket for quick and easy connection.
- Built in LED in sensor giving confirmation of remote control settings and easy test operation.

2.2 Dimension (see Fig. 1-A & Fig. 1-B)

Sensor: 80 dia. x 52mm

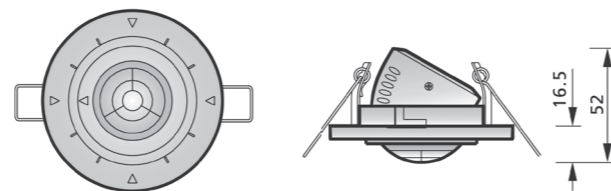

Fig. 1-A

Power unit: 124 x 58 x 37.6mm

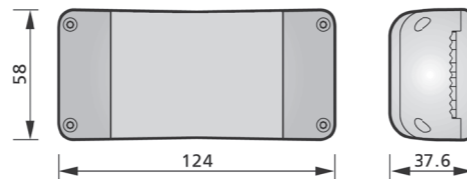

Fig. 1-B

3 Installation and Wiring

Please disconnect power completely and read the entire instruction manual carefully before installation.

PDFM362 – 6A breaker
 A circuit breaker (250VAC,6A) type C according to EN60898-1 of load shall be installed in the fixed wiring for protection of load II.

PDFM361, PDFM362 – 10A breaker
 A circuit breaker (250VAC,10A) type C according to EN60898-1 of load shall be installed in the fixed wiring for protection of load I.

3.1 Select the required location

3.1.1 Sensor adjustment

Fig. 2 shows the way coverage alters with ceiling height and with adjustments of the METER dial setting.

Section 4.2.3 shows how tilting and rotating the sensor can produce different fields of coverage.

Side View

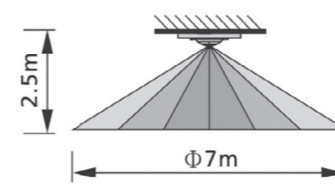

Top View (showing individual beam pattern at floor level)

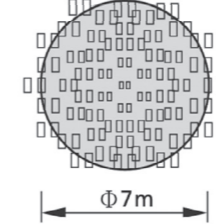

Fig. 2

Ceiling Height (H)	Detection Coverage Diameter (D) with METER on +
2m	7m
2.5m	7m
3m	10m
3.5m	12m
4m	12m
4.5m	12m

If the METER control is turned to – the coverage diameter is substantially reduced.

We do not recommend the use of these units with ceiling heights greater than 4.5m.

3.1.2 Helpful tips for installation

As the sensor responds to temperature change or moving heat sources, please avoid the following conditions:

- Avoid highly reflective surfaces within the detection range.
- Avoid movable objects e.g. curtains and plants in the detection range (these may cause erroneous detections when moved by air flow from fans or air conditioner).
- Avoid heat sources (e.g. heating vents, radiators, air conditioners and filament lamps) in detection range.
- Avoid fans drawing air across the sensor lens.

3.2 Wiring diagrams

3.2.1 PDFM362 controller (see Fig. 3).

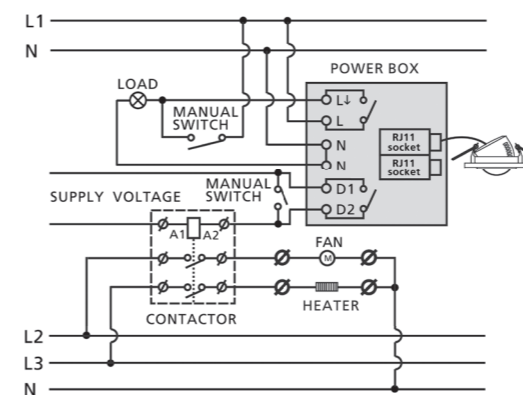

Fig. 3

3.2.2 One load is controlled by two sensors (see Fig. 4).

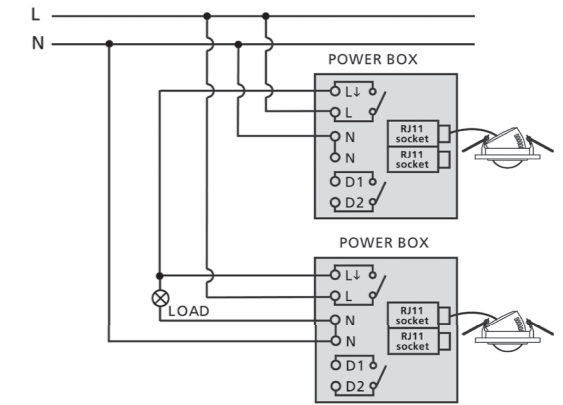

Fig. 4

3.2.3 PDFM361 for one sensor (see Fig. 5).

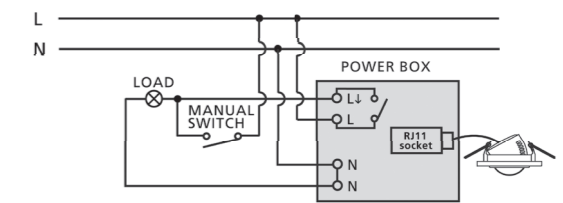
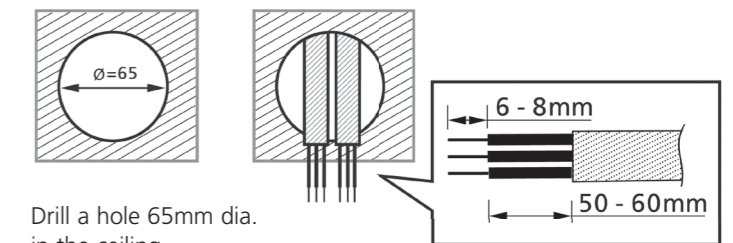

Fig. 5

3.3 Installation procedure

3.3.1 To install the detector, cut a hole with diameter of 65mm in the ceiling board and bring the power cable through the hole. Strip off cable sheath and core insulation according to Fig. 6.



Drill a hole 65mm dia. in the ceiling.

Fig. 6

3.3.2 Unscrew protection covers on power box with a cross point screwdriver. The RJ11 socket (use sensor A only) is for sensor connection and screw terminals are for power and load(s). (See Fig. 7).

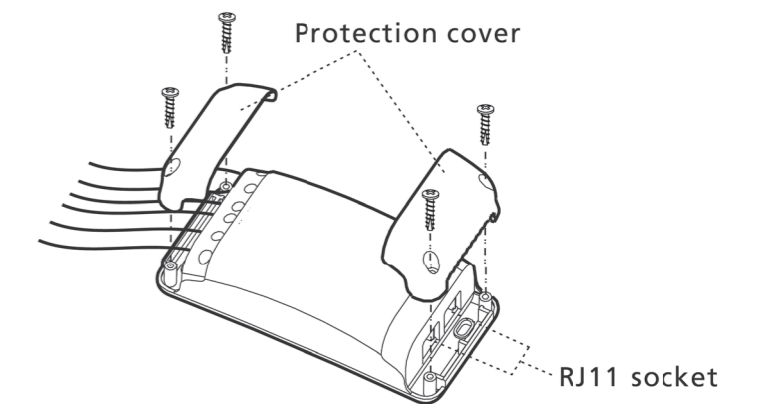

Fig. 7

3.3.2 (cont). The protection covers have teeth (see Fig. 8-A) giving a degree of cable clamping if power and load are connected by individual wires (0.8 – 1.8mm dia.).

If connection is by cable (9 – 11mm dia.) then use of a coarse rat-tailed file to open out as many of the holes as necessary using the markings on the inside of the protection cover as an approximate guide (see Fig. 8-B).

Referring it to the appropriate wiring diagram insert the wires into the correct screw terminals and tighten fully. Then plug the sensor lead into SENSOR A socket only.

Use the coarse rat-tailed file to open a single hole (smaller than that above) in the remaining protection cover to take the sensor cable with a degree of strain relief. Secure down the protection covers.

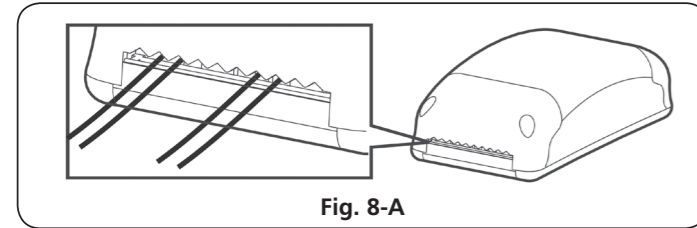

Fig. 8-A

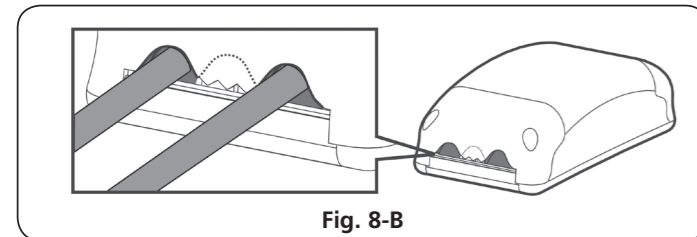

Fig. 8-B

3.3.3 Feed the wires/cables followed by the power unit through the 65mm dia. ceiling hole (see Fig. 9).

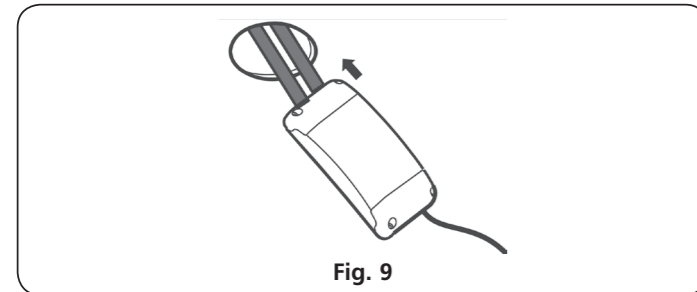

Fig. 9

3.3.4 Force the spring clips back until they can feed into the ceiling hole (see Fig. 10-A) and then push the sensor upwards into place so that its flange fits tightly against the ceiling (see Fig. 10-B).

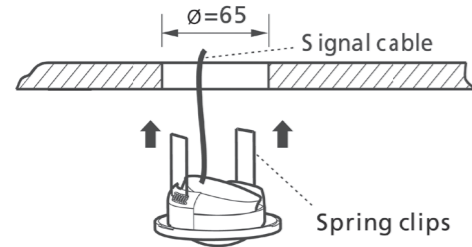

Fig. 10-A

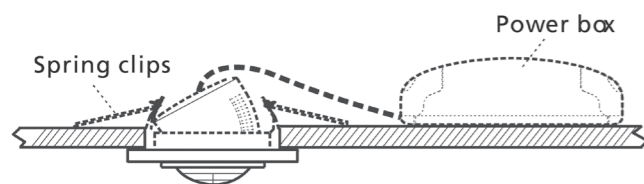

Fig. 10-B

4 Test and Operation

4.1 Time, LUX and Meter Controls

Following marked values (excepting TEST and $\sqrt{15}L$) are approximate, the values are continuously adjustable over the control range (see Fig. 11-A & Fig. 11-B).

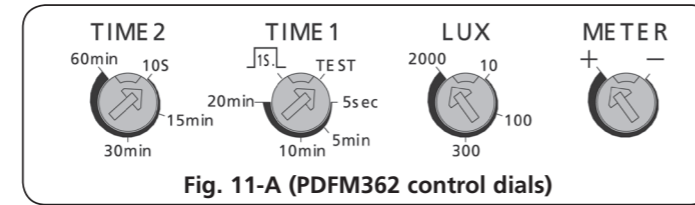

Fig. 11-A (PDFM362 control dials)

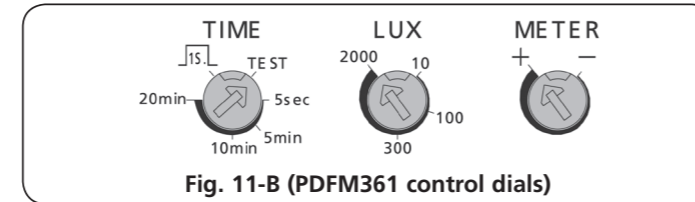

Fig. 11-B (PDFM361 control dials)

4.1.1 TIME control adjustment

These are delay times between the sensor being triggered and the controller switching off assuming no further detections are made. If there are additional detections the time delay applies from the latest detection.

PDFM362:

TIME 1: Adjustable from 5 sec. to 20 min. (lighting). (Extendable to 30 min. and 60 min. when in use with the IR10 remote controller).

TIME 2: Adjustable from 10 sec. to 60 min. (HVAC).

PDFM361:

TIME: Adjustable from 5 sec. to 20 min. (lighting). (Extendable to 30 min. and 60 min. when in use with the IR10 remote controller).

4.1.2 LUX control adjustment

The LUX level below which the sensor will operate is adjustable from 10 LUX (operation only after dusk) to 2000 LUX (operation at any light level).

4.1.3 METER control adjustment

This control sets the diameter of detection coverage at floor level. Assuming a ceiling height of 2.5m at the + end of the scale the coverage diameter will be 7m, at the - end of the scale the coverage diameter will be 1m.

The affect of METER control at other ceiling heights is shown in section 3.1.

4.2 Test Mode

4.2.1 Sensor warm up

The detector will take a minimum of 60 seconds to warm up when the power is connected to it for the first time or if the power is being re-connected after being turned off.

During this period load I and the sensor LED will both be on. After the warm up is finished the sensor will revert to operation according to the settings of the controls on the sensor body.

4.2.2 LED function

There is a red LED (see Fig. 12) built into the sensor and visible through the PIR lens that shows the status of the loads and enables testing to be carried out without the loads being connected.

If the IR10 remote controller is in use the LED will flash to give confirmation of the commands and adjustments made by the IR10.

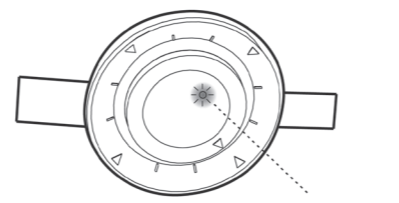

Fig. 12

4.2.3 Adjusting sensor head

The sensor head can be tilted by as much as 30° off axis as shown in Fig. 13A. This can be achieved by using a flat blade screwdriver as shown in Fig. 13B.

Fig. 13C shows the tilt angle markings on the sensor body. The tilt angle is read off against the edge of the mounting flange.

Fig. 13D shows the detection coverage for various tilt angles. The tilt angle can be used in conjunction with rotation of the sensor head within the flange up to 350° to give the required coverage in any direction. The markings on the sensor mounting flange (see Fig. 13E) giving 30° per division provide a useful way of adjusting angular position.

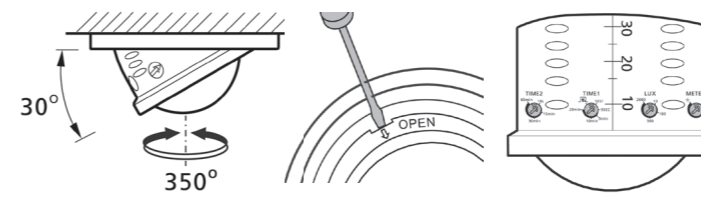

Fig. 13A

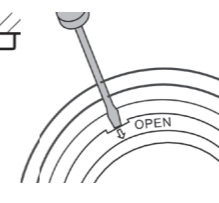

Fig. 13B

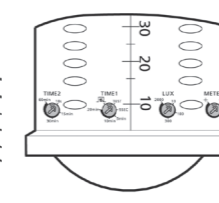

Fig. 13C

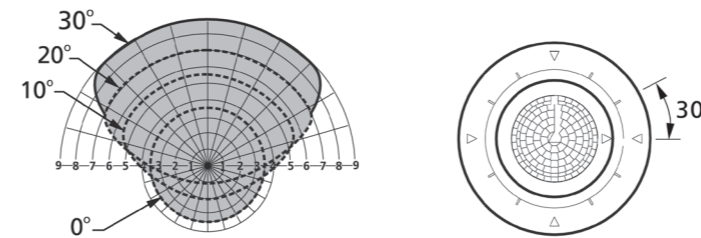

Fig. 13D

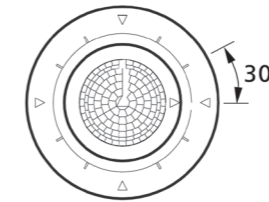

Fig. 13E

4.2.4 Walk test

Turn supply on and wait at least 60 seconds for the system to settle down.

Turn Time 1 control to the Test position. This means that the sensor LED and load I will turn on for 2 seconds after triggering and then be off for 3 seconds after which the sensor can be re-triggered. The triggering is independent of light level.

The installer should move around in the detection area to establish that it is all covered. If necessary the tilt and rotation of the sensor should be adjusted, after which the area should be walk tested again to confirm coverage is as required.

To confirm that load 2 (HVAC) is operating correctly for a PDFM362, carry out the following:-

Turn LUX (light level) to its minimum value (10 lux) to stop load 1 (lights) from turning on. Then turn TIME 2 (HVAC) to minimum value (10s) and carry out a limited walk test to confirm correct operation of load 2.

5 Troubleshooting

When the PDFM362 PDFM361 is not working as expected go through the troubleshooting guide below.

Problem	Possible Cause	Suggested Solution
Lights do not turn on.	1. Power is not turned on. 2. Incorrect control dial setting. 3. Incorrect wiring. 4. Faulty load.	1. Switch on the power. 2. Check if control dials are set to the correct position, then supply the power to check if the LED will turn on. 3. Refer to wiring diagrams (Fig. 3 to Fig. 5) 4. Replace the faulty load.

Problem	Possible Cause	Suggested Solution
Lighting or HVAC does not turn off.	1. Incorrect time setting. 2. Incorrect wiring.	1. Check that the correct delay time is set on either TIME 1 or TIME 2 control dial. Then determine if nuisance triggering is keeping the unit turned on. 2. Make sure supply and load wires are connected correctly.
LED does not turn on.	1. Out of detection range. 2. Power supply not on. 3. 'TIME' knob setting isn't on 'Test'. 4. Incorrect wiring.	1. Walk within the effective detection range. 2. Switch the power on. 3. Turn the control position to 'Test'. 4. Refer to wiring diagrams (Fig. 3 to Fig. 5).
Nuisance triggering.	There are heat sources, HVAC vents/fans, highly reflective surfaces or anything which may be swayed by air movement within the detection coverage.	Avoid aiming the sensor toward any heat sources, such as air conditioners, electric fans, heaters or any highly reflective surfaces. Make sure there are no swaying objects within the detection coverage.

6 Optional Remote Control – IR10

PDFM362 PDFM361 can also be controlled by the infrared remote controller IR10. As well as allowing remote setting of times and light level the IR10 also enables continuous operation for 8 hours in ON or OFF modes as well as continuously in detection mode controlled by or independent of light level.

The IR10 is invaluable during commissioning enabling changes to be made without resorting to ladders.

Further to this the IR10 can download stored settings from one sensor to additional sensors in the same area.

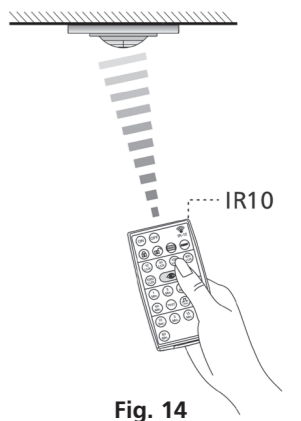

Fig. 14

3 Year Guarantee

In the unlikely event of this product becoming faulty due to defective material or manufacture within 3 years of the date of purchase, please return it to your supplier in the first year with proof of purchase and it will be replaced free of charge. For years 2 and 3 or any difficulty in the first year telephone the helpline on 020 8450 0515.

For assistance with the product please contact:

HELPLINE

020-8450-0515

or email helpline@timeguard.com



For a product brochure please contact:

Timeguard Ltd.

020-8452-1112

or email csc@timeguard.com

A Huben Group company