

ED-516 ETHERNET TO Digital IO 16 Inputs

ED-516

- 16 Digital Inputs
- Monitor any input from TTL to high voltage high current industrial devices
- 0 to 30 Volt inputs ideal for dry/Volt free contacts or wet contacts
- Supports Modbus TCP protocol

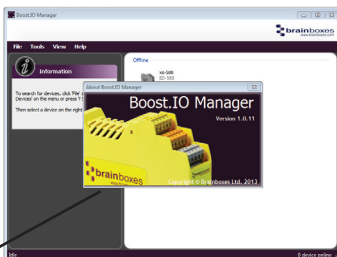

Easy to use Interface:
Great features for
remote monitoring

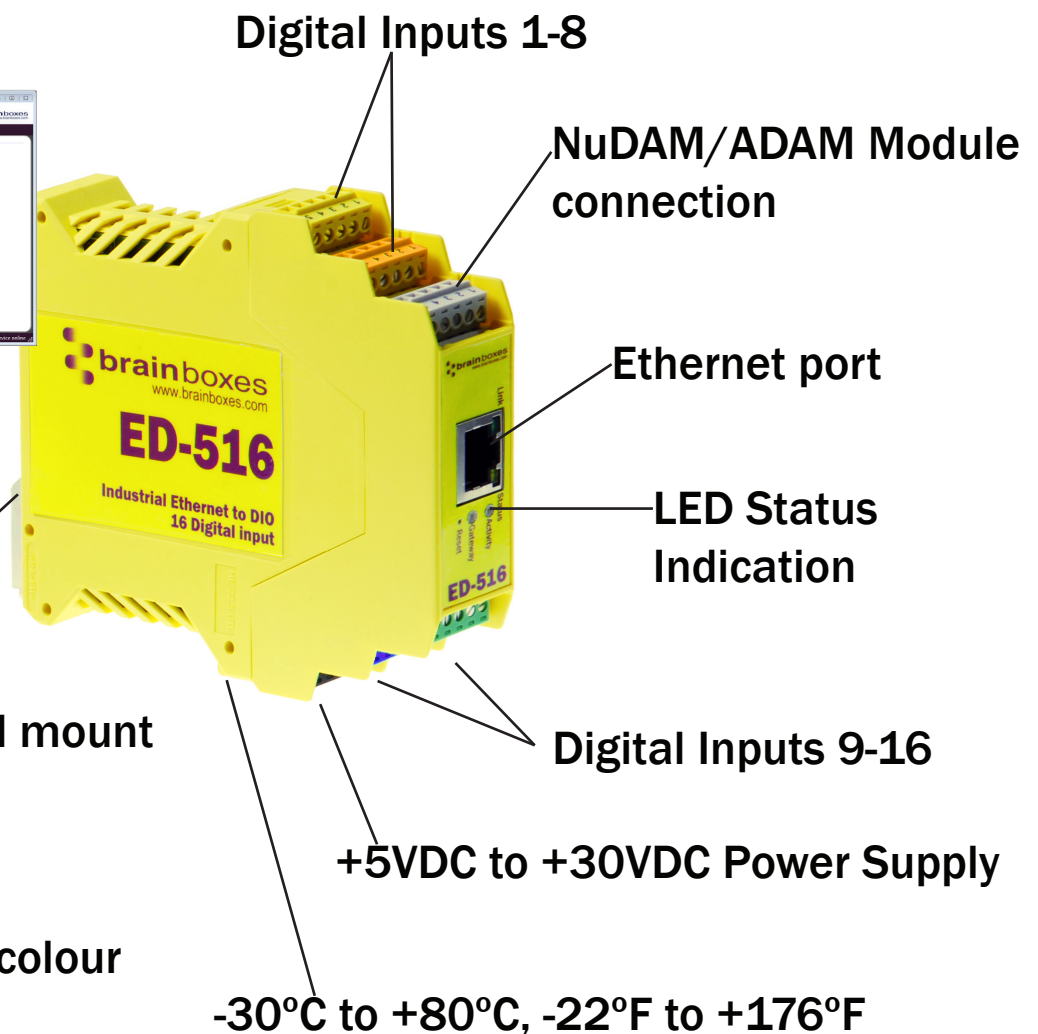

Integral DIN rail mount



Easy wire: removable, colour
coded terminal blocks

Usage Model for ED-516

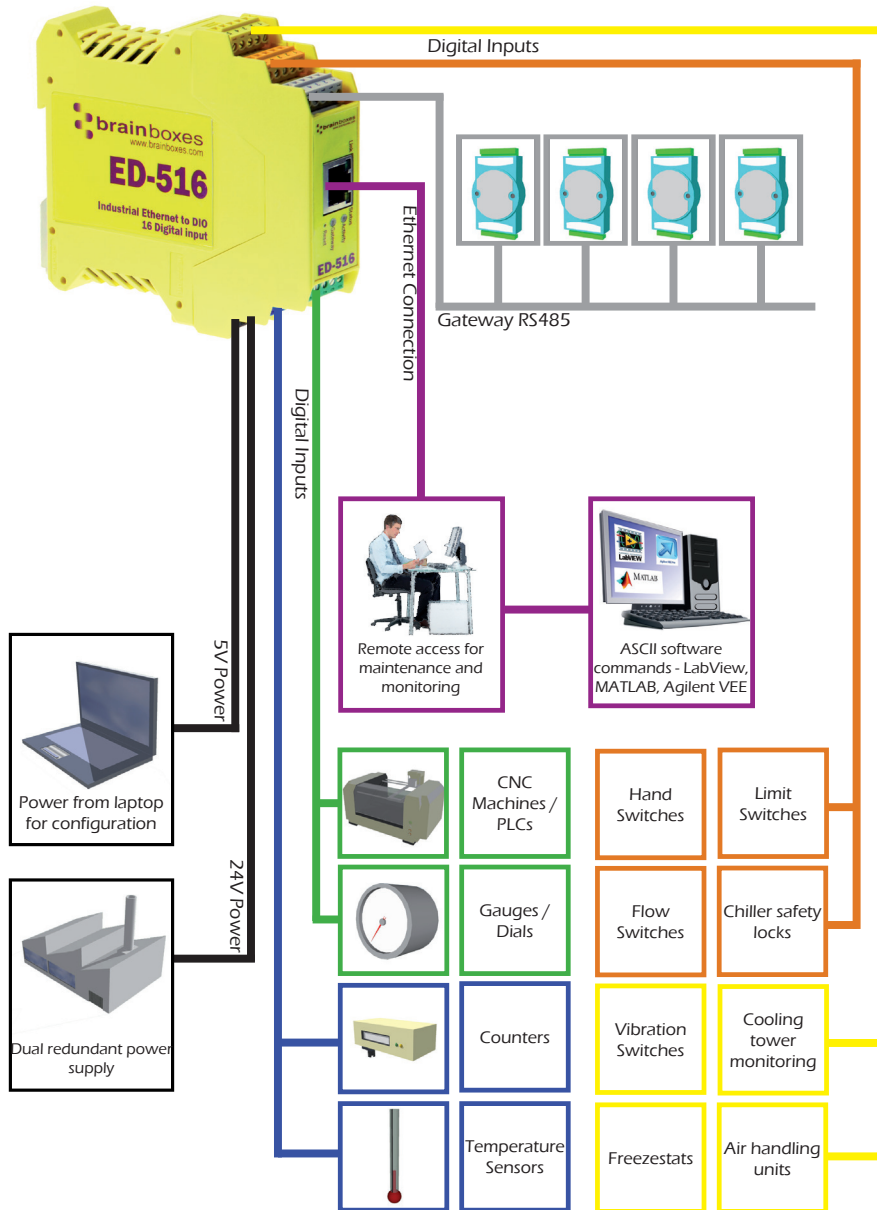

Dry/Volt free Contact Example

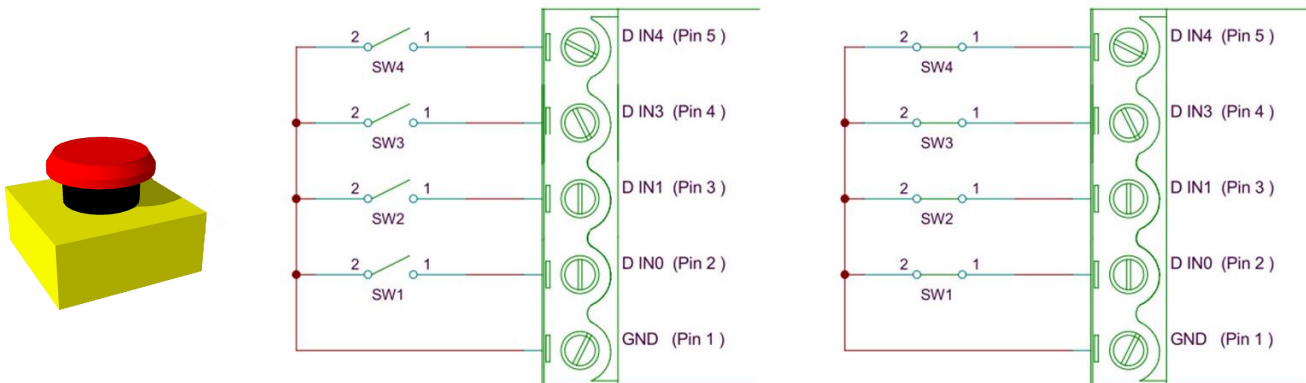

Specification

Input Channels	16 non-isolated input channels
Low Logic Level	0V to +1.0V
High Logic Level	+2.0V to +30V
NPN/PNP	One jumper configures all inputs with either pull-up for NPN (contact closes to 0V) type sensors, or pull-down for PNP (close to V+) type sensors
Input counting	User programmable – counts positive or negative transitions Up to 250Hz count rate 16-bit (65335 count) or 32-bit (4.2 billion count) counters Counter values persist over power-off periods
Input latching	Triggered by user programmable positive or negative edges, stays true until acknowledged
Debouncing	User programmable debouncing for noisy contact inputs

IP-20 rated non-conducting polyamide case
Integrated DIN rail mount with functional earth connection
Slim shape has a small foot print for when DIN rail space is a premium

Removable screw terminal blocks make installation easier and quicker
Colour coded blocks and ports prevents incorrect connection
Numbered Pins simplifies wiring and removes confusion

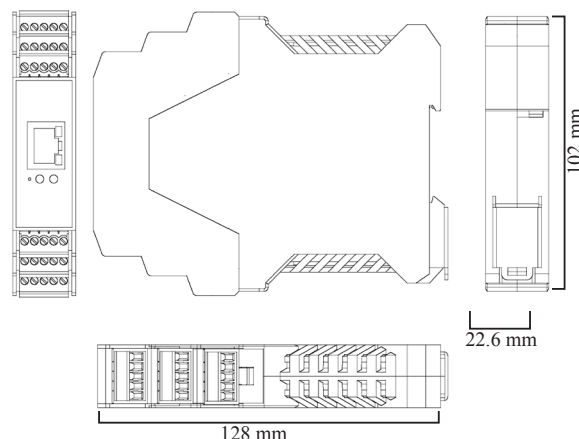

Screw Terminals	3.5mm pitch, #22 - #14, 0.5mm²-2.5mm² pin power supply
Wire Thickness	0.150 inch, 3.81mm, 20 pins, 12+8 screw terminals, #26 - #16 AWG, 0.14mm²-1.3mm²

Operating Temperature	+30°C to +80°C, -22°F to +176°F
Storage Temperature	-40°C to +85°C, -40°F to +185°F
Ambient Relative Humidity	5 to 95% (non-condensing)

Monitor CPU temperature via the web interface or programmatically using ASCII commands.
Redundant dual power input allows a second power supply to be fitted as a back-up to prevent down time should one power source fail.
Can use a 5 Volt power from any computer USB port via optional accessory cable PW-650 - Useful for configuring the device from a laptop in the field.

Power Consumption	2.5 Watt Max
Power Supply input	Unregulated +5VDC to +30VDC, reverse polarity protection

Isolation	1500 VRMS Magnetic isolation from Ethernet
Ethernet Port	1 x RJ45 jack, 10/100Mhz autosensing, crossover auto sensing (Auto MDIX)
Protection	1,500 Volts magnetic isolation between I/O ports and network
Network Protocols	ICMP, IP, TCP, DHCP, Telnet, HTTP
Connection to Network	Ethernet 10BaseT / 100BaseTX
Webserver Interface	Configure IP address, monitor state of I/O lines, set the Watchdog Timers Output Reset Value, Set Power on digital output value
Programming Interface	No device driver needed, just open a TCP connection and send simple ASCII or Modbus commands. Software drivers give local COM Port interface for communication.
Utility Programs	Find device, configure IP address, test communication with console

Industry Standard Modbus TCP Protocol:

Device works as a Modbus TCP server. Modbus TCP can be used on the input and output lines.

Examples include:

	Modbus access type	Supported Modbus function codes	Logical address	984 style address	IEC 61131 address
Read digital inputs	Coil	1	0x0020...	00033...	%M32...
Read digital inputs	Discrete input	2	0x0000...	10001...	n/a
Read digital inputs	Input register	4	0x0020	30033	n/a
Read DI counter values	Input register	4	0x0000...	30001...	n/a
Read DI counter values	Holding register	3	0x0000...	40001...	%MW0...
Clear DI counters	Coil	5, 15	0x0200...	00513	%M512...

Familiar ASCII Command Protocol:

When not using Modbus the ED range of devices can use the de facto industry standard ASCII command protocol implemented in the popular ADAM/NuDAM/EDAM modules. Examples include:

\$01M	read the name of device address 01
!01ED-588	device 01 replies that its name is ED-588
\$01F	read firmware version number of device address 01
!012.54	firmware version of device 01 is 2.54
@01	read digital input output status of device 01
>1A45	device 01 digital input data= 1A (=00011010) digital output data = 45 (=01000101)
\$012	read configuration of device 01
!01400500	device 01 40=typecode, 05 =gateway RS485 port is at 4800 Baud, 00=No checksum

COM Port on Windows	On a PC running the Microsoft Windows family of OS's the ED Boost.IO Manager provides a standard COM port interface so enabling thousands of proven legacy applications to work straight out of the box.
Industry Standard Packages	The COM port based driver means that ED-xxx devices are completely compatible with all popular packages such as: LabView, MATLAB, Agilent VEE.
Software Platforms	APIs and sample program code for: Microsoft .NET, C#, Visual Basic, C++, JavaScript, PHP, Java, Objective-C
Devices Supported	The ED sample codes running on Operating Systems such as Windows XP, Server 2008, Server 2012, Windows 7, Windows 8, and Linux based systems such as Android and Raspberry Pi allow you to run your applications on Servers, Desktops, Laptops, Tablets, Phones or low cost embedded devices, almost any device you wish.
Configuration Options	Windows Utility, Web Interface: Boost.IO driver provides familiar Serial COM port interface
OS Compatibility	Legacy COM porty drivers for: Microsoft Windows 10 32 bit & 64 bit Editions / Microsoft Windows 8 32 bit & 64 bit Editions / Microsoft Windows 7 32 bit & 64 bit Editions / Windows Server 2008 32 bit & 64 bit Editions / Server 2012/ Windows Server 2008 & Windows Server 2000/ Windows Vista 32 bit & 64 bit Editions / Windows Server 2003 32 bit & 64 bit Editions. TCP and web browser interface for other OS's & Linux, e.g. Android, Raspberry Pi
Industry Approvals	C-Tick, AEO (C-TPAT), WEEE, RoHS
Microsoft Approvals & Signed Drivers	Microsoft Certified Gold Partner Windows 10 32 bit & 64 bit Editions Windows 8 32 bit & 64 bit Editions Windows 7 32 bit & 64 bit Editions Windows Server 2008 32 bit & 64 bit Editions Windows Server 2008 & Windows 2000
OEM option	Available for bulk buy OEM
Made In	Manufactured in the UK by Brainboxes
Customisable	Brainboxes operate a 'Perfect Fit Custom Design' policy for volume users. More info: sales@brainboxes.com
Warranty Support	Lifetime - online registration required Lifetime Web, Email and Phone Support from fully qualified, friendly staff who work in and alongside the Product Development Team

Packaging	Installation CD (with manual, Microsoft signed drivers & utilities), Quick Start Guide
Device	Ethernet 16 DI
Packaged Weight	0.215 kg, 0.47 pounds
Packaged Dims	235(l) x 170(w) x 62(h) mm, 9.25(l) x 6.69(w) x 2.44(h) inches
GTIN Universal Code	837324003185

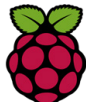
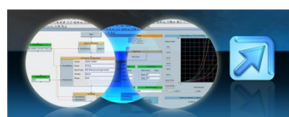

Optional Accessories



PW-600: Power supply with connectors for UK, USA, EU and AUS mains socket. 'Tails' are suitable for connecting to screw terminal blocks



PW-650: USB connector fits any standard USB port, such as on a laptop or desktop PC, providing 5V power to a prewired screw terminal block useful for when you are configuring your ED device